

TECHNISCHE INFORMATIONEN

OCTANORM REINRAUMSYSTEME

PHARMAZIE UND MEDIZINTECHNIK

Wandsysteme mit Wandschalen

Technisches Datenblatt

Wandsystem P90

Wandsystem P98

THE
WORLD
OF
SYSTEMS

OCTANORM 



TECHNISCHES DATENBLATT

WANDTYP P90

Wandsysteme mit vorgehängten Wandschalen

Oberfläche
Stützen / Profile

Stahl natur

Oberfläche
Paneele

Pulverbeschichtet oder
Edelstahl geschliffen

Paneele

Stahlblechschalen mit rückseiti-
ger, vollflächiger und eingeklebter
Gipskartonplatte

Standardraster

1200 mm

Standardfarbe

RAL 9010

Füllung

keine oder auf Anfrage

Wandhöhe

2500 mm bis 4500 mm je nach
vorliegendem Raster

Wandstärke

90 mm

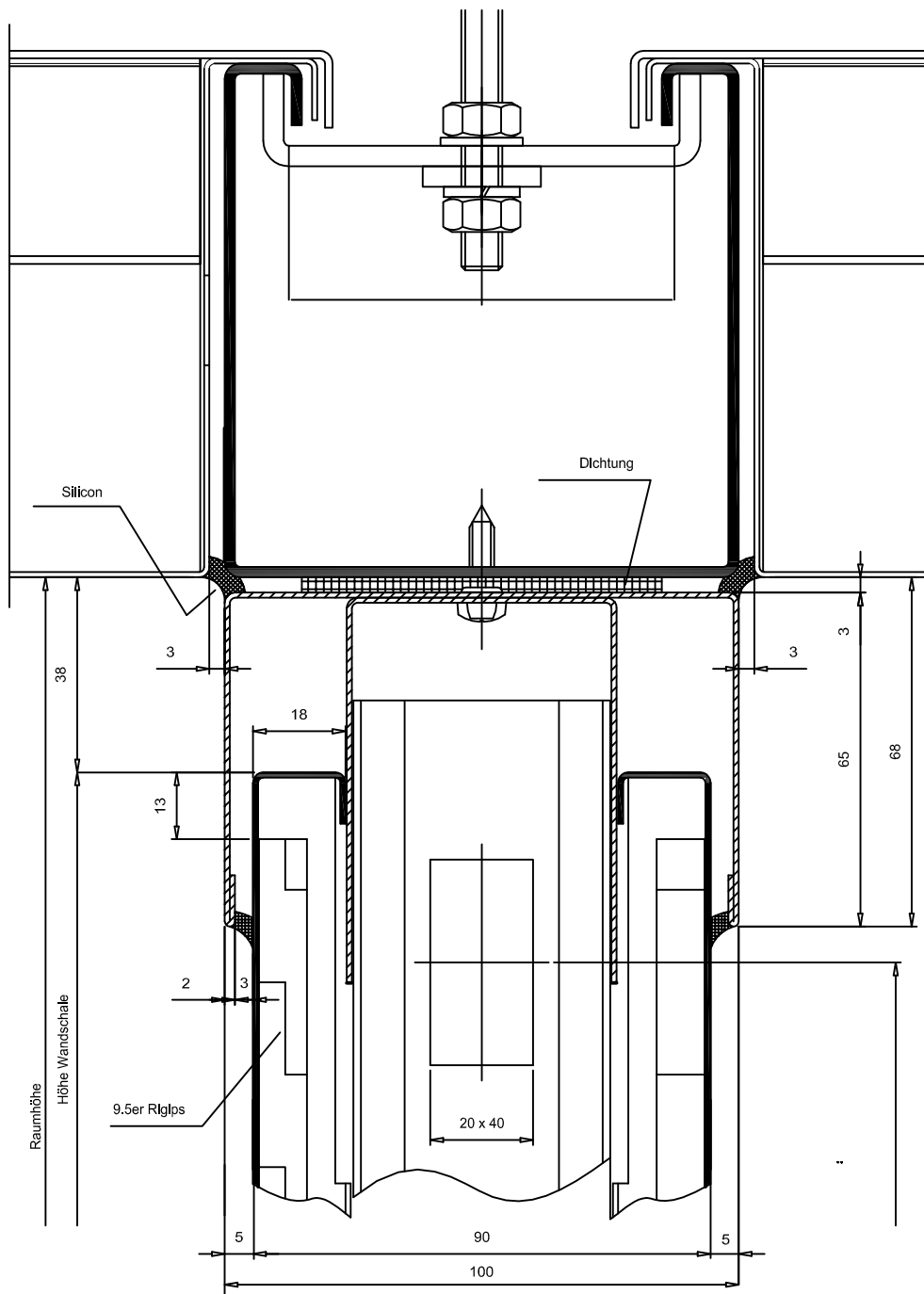

Alle Toleranzen nach DIN ISO 2768 mittel		Material		
<small>This drawing is our literary property and may neither copied nor to be exposed approachable to third persons without our agreement; according to German Copyright Act</small>				
		Datum	Name	Description / Bezeichnung: D 005 Wand- Deckenanschluss an Bandraster
		Gezeichnet	24.07.2014 jk	
		Kontrolliert		
		Norm		
		Projekt Nr.		Z-Nr: VRS_P90_11_0001
		PRO_XXX		
Status	Änderungen	Datum	Name	<div style="text-align: right; font-size: 24pt; font-weight: bold;">1</div> <div style="text-align: right;">A4</div>

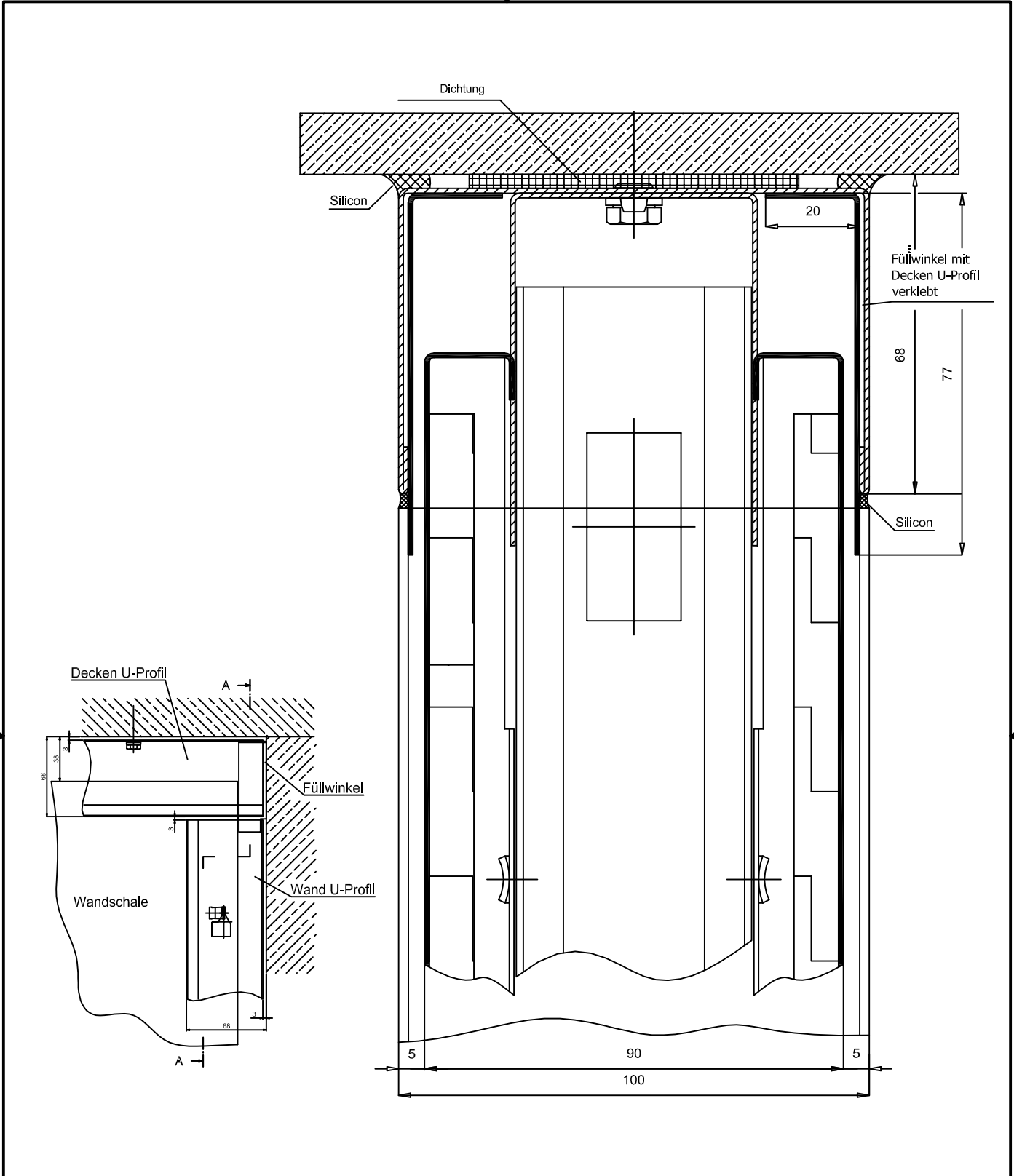

Alle Toleranzen nach DIN ISO 2768 mittel		Material		
This drawing is our literary property and may neither copied nor to be exposed approachable to third persons without our agreement; according to German Copyright Act				
		Datum	Name	Description / Bezeichnung: D 005 A Wand- Deckenanschluss Trennwand Voll
		Gezeichnet	24.07.2014 jk	
		Kontrolliert		
		Norm		
		Projekt Nr.		Z-Nr: VRS_P90_11_0002
		PRO_XXX		
Status	Änderungen	Datum	Name	1 A4

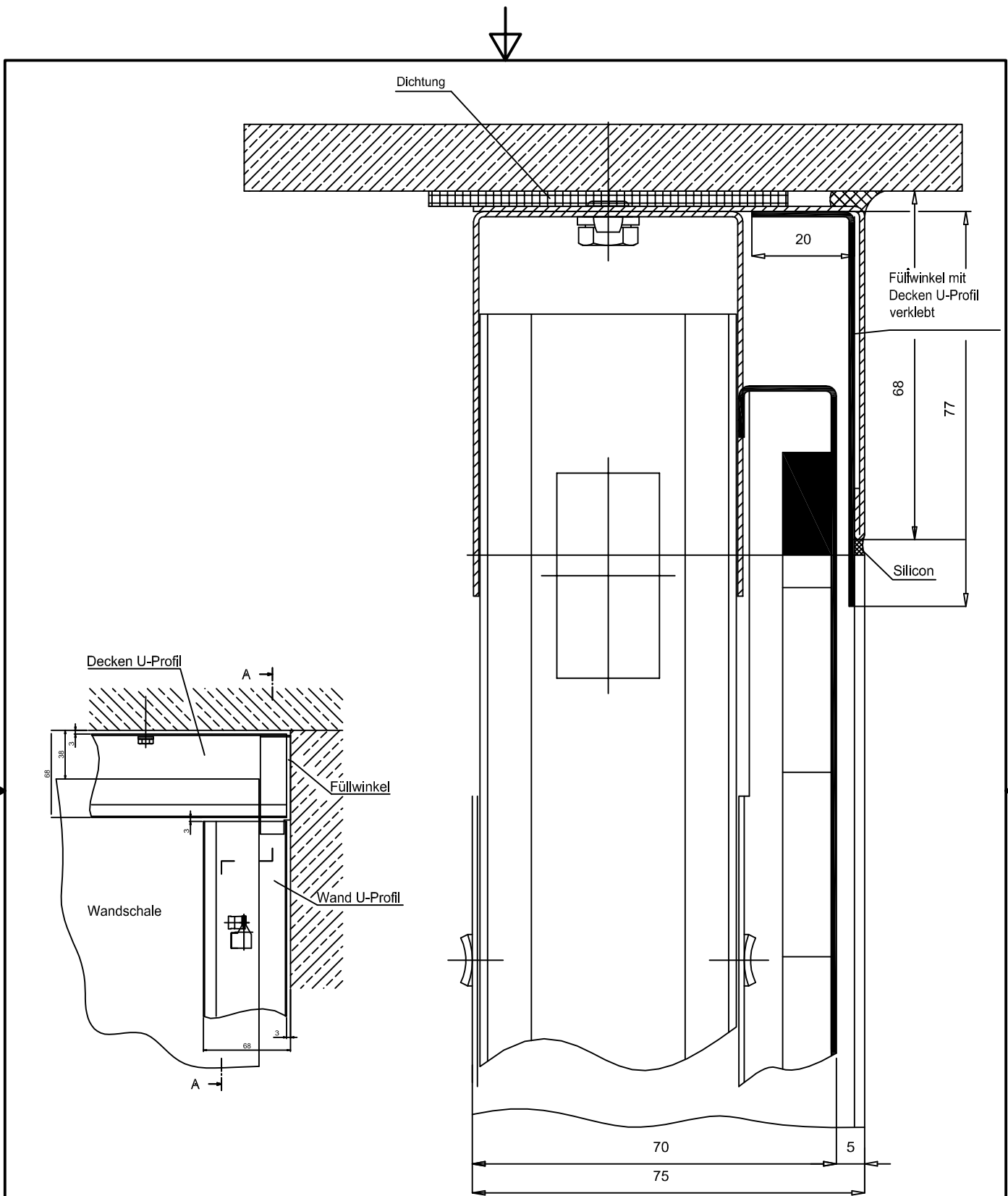

Alle Toleranzen nach DIN ISO 2768 mittel		Material		
<small>This drawing is our literary property and may neither copied nor to be exposed approachable to third persons without our agreement; according to German Copyright Act</small>				
		Datum	Name	Description / Bezeichnung: D 005 B Wand- Deckenanschluss Trennwand Wandschale
		Gezeichnet	24.07.2014 jk	
		Kontrolliert		
		Norm		
		Projekt Nr.		Z-Nr: VRS_P90_11_0003
		PRO_XXX		
Status	Änderungen	Datum	Name	1 A4

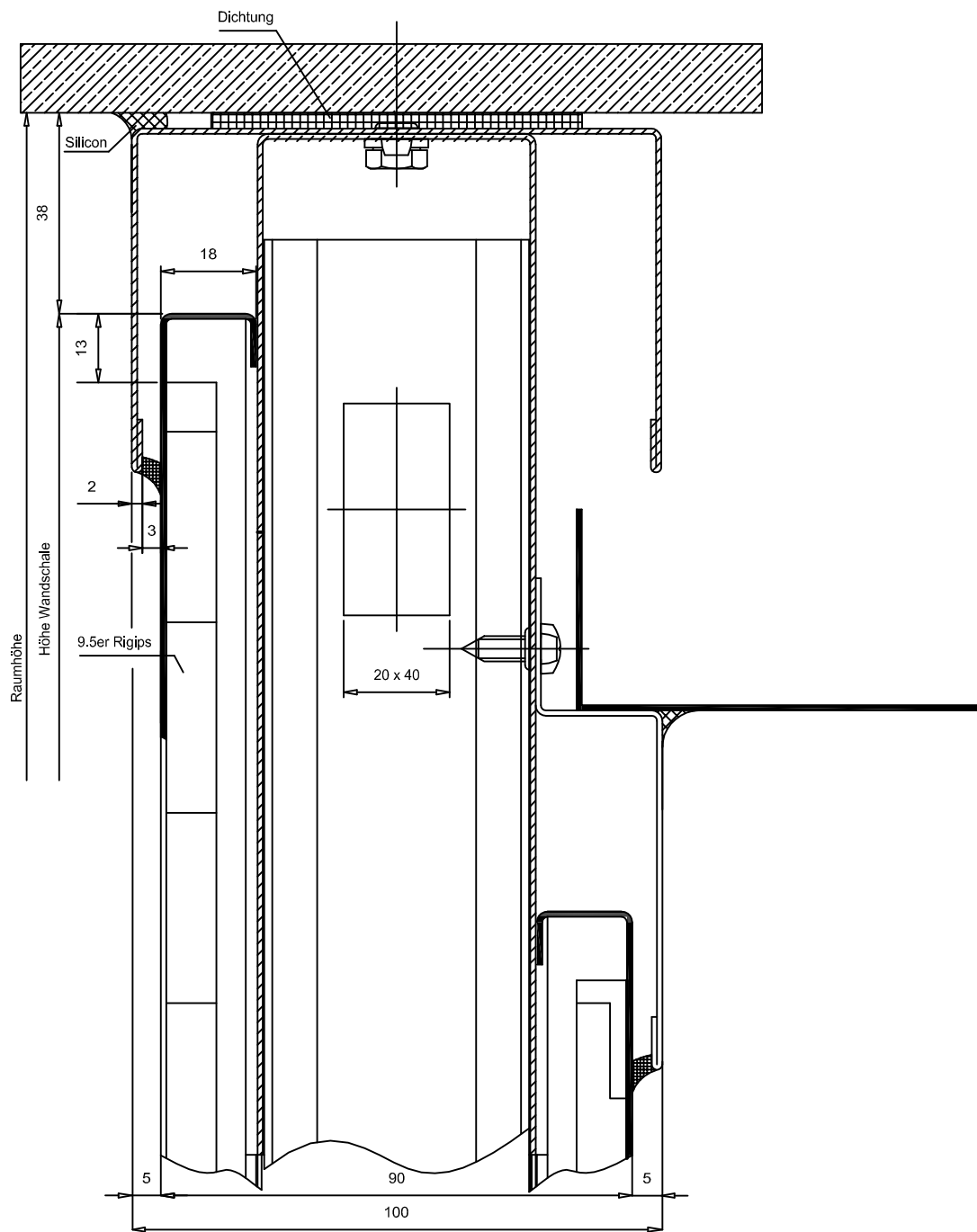

Alle Toleranzen nach DIN ISO 2768 mittel		Material		
<small>This drawing is our literary property and may neither copied nor to be exposed approachable to third persons without our agreement; according to German Copyright Act</small>				
		Datum	Name	Description / Bezeichnung: D 005 C Deckenanschluss mit Deckensprung
		Gezeichnet	24.07.2014 jk	
		Kontrolliert		
		Norm		
		Projekt Nr.		Z-Nr: VRS_P90_11_0004
		PRO_XXX		
Status	Änderungen	Datum	Name	<div style="text-align: right; font-size: 24pt; font-weight: bold;">1</div> A4

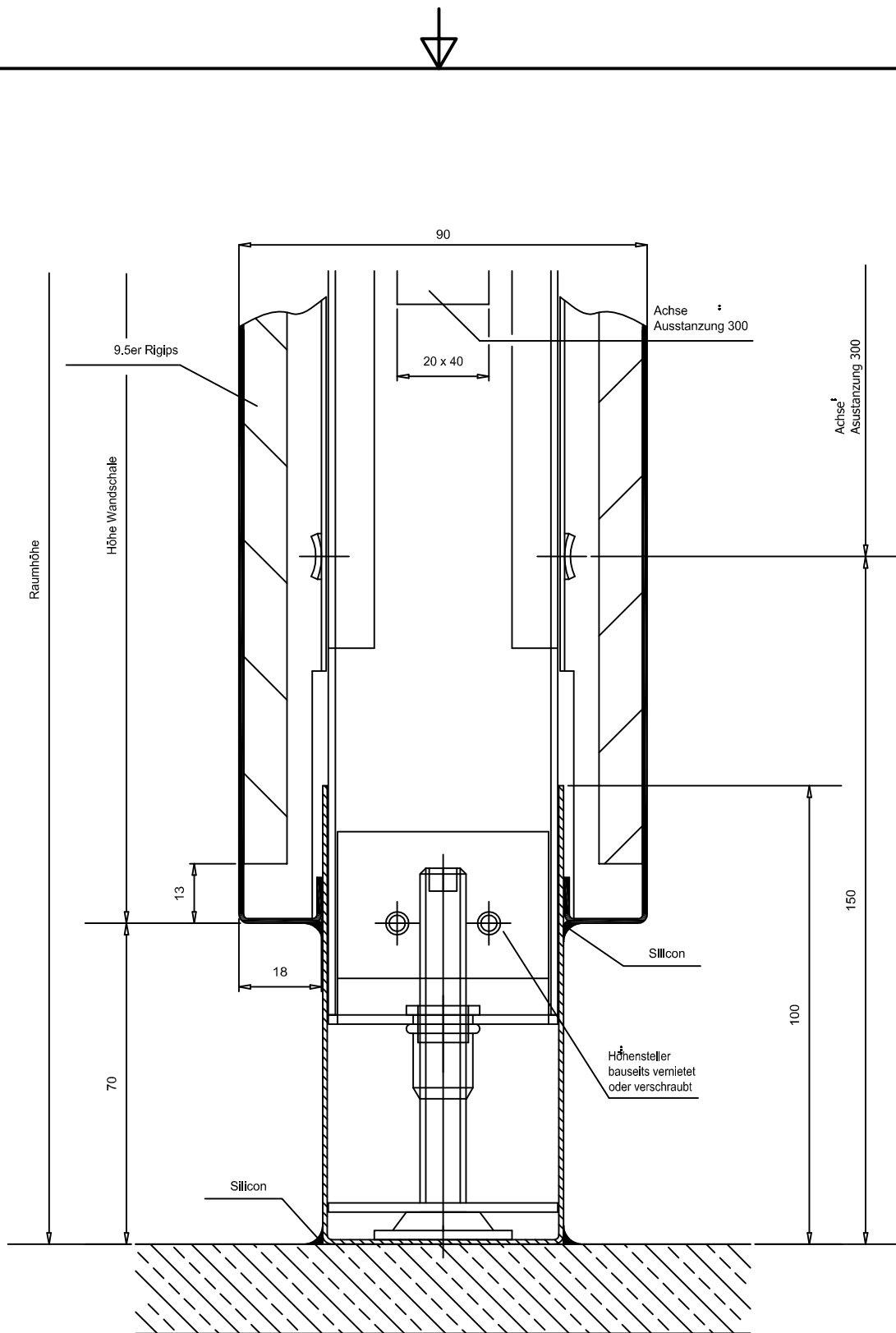

Alle Toleranzen nach DIN ISO 2768 mittel		Material		
<small>This drawing is our literary property and may neither copied nor to be exposed approachable to third persons without our agreement; according to German Copyright Act</small>				
		Datum	Name	Description / Bezeichnung: D 006 Sockelausbildung Wand-Bodenanschluss
		Gezeichnet	24.07.2014 jk	
		Kontrolliert		
		Norm		
		Projekt Nr.		Z-Nr: VRS_P90_11_0005
		PRO_XXX		
Status	Änderungen	Datum	Name	1 A4

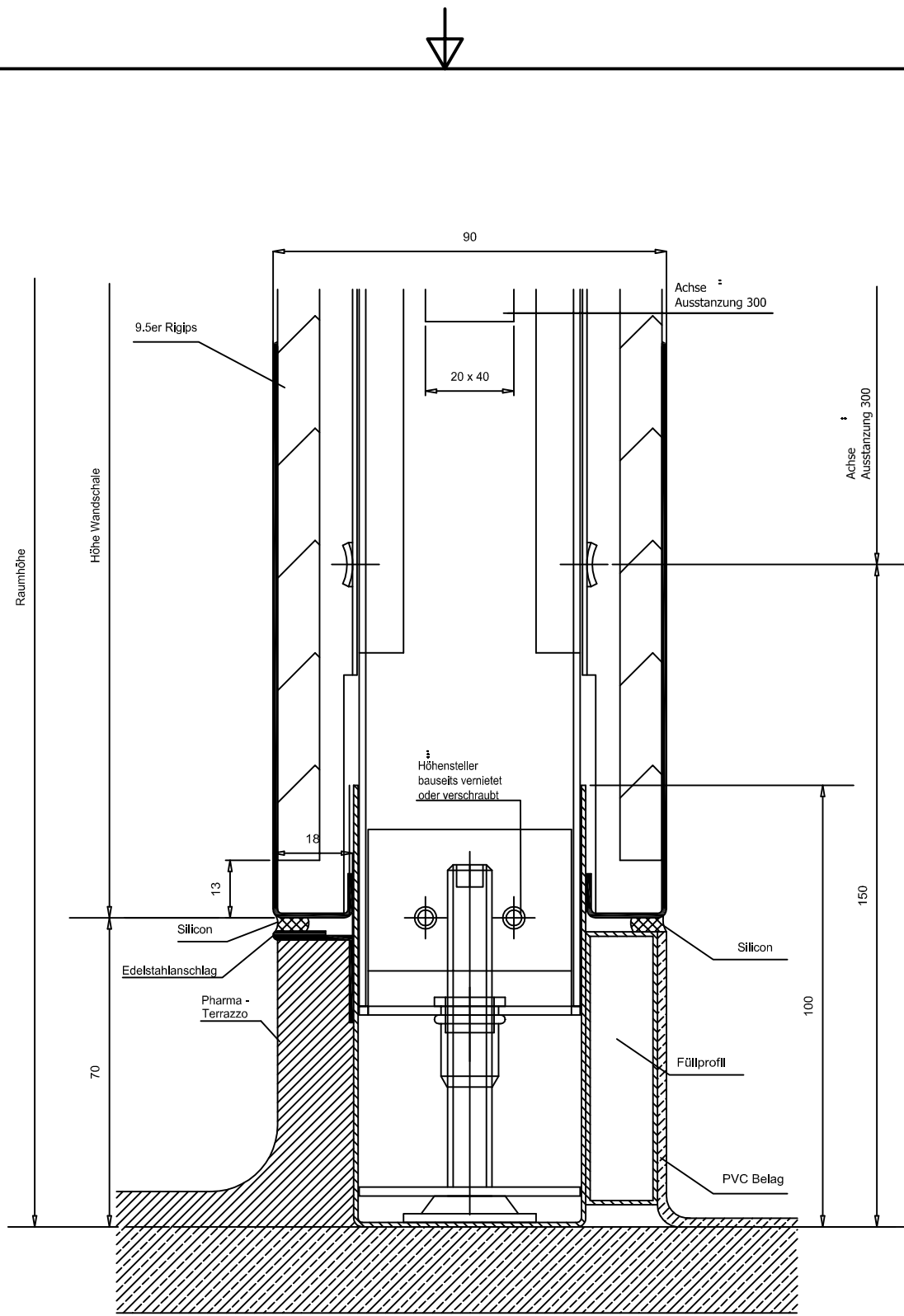

Alle Toleranzen nach DIN ISO 2768 mittel		Material		
<small>This drawing is our literary property and may neither copied nor to be exposed approachable to third persons without our agreement; according to German Copyright Act</small>				
		Datum	Name	Description / Bezeichnung: D 006 A Sockelausbildung Wand - Bodenanschluss Pharma - Terrazzo / PVC Belag
		Gezeichnet	24.07.2014 jk	
		Kontrolliert		
		Norm		
		Projekt Nr.		Z-Nr: VRS_P60_11_0006
		PRO_XXX		
Status	Änderungen	Datum	Name	<div style="text-align: right; font-size: 24pt; font-weight: bold;">1</div> <div style="text-align: right;">A4</div>

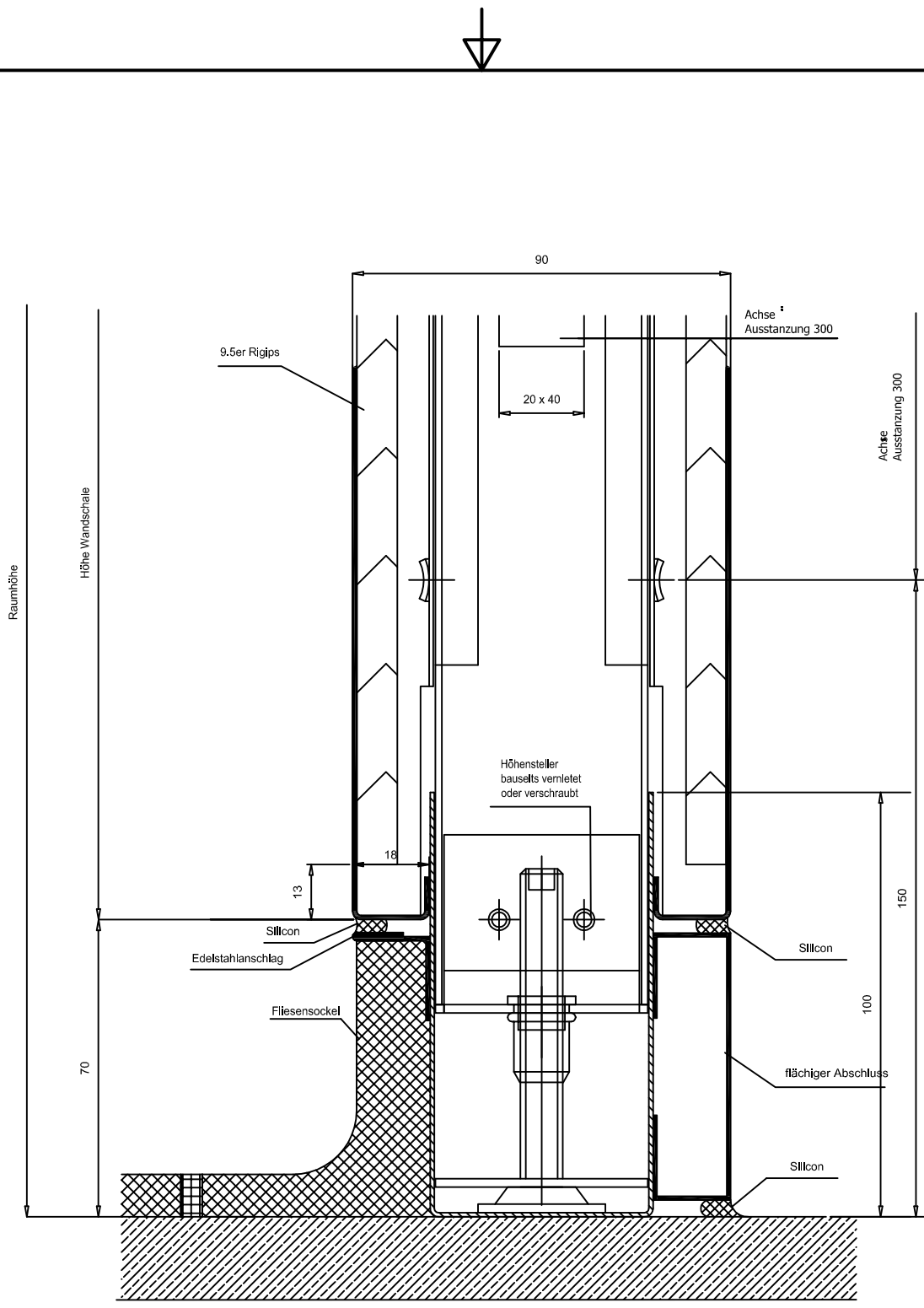

Alle Toleranzen nach DIN ISO 2768 mittel		Material		
<small>This drawing is our literary property and may neither copied nor to be exposed approachable to third persons without our agreement; according to German Copyright Act</small>				
		Datum	Name	Description / Bezeichnung: D 006 B Sockelausbildung Wand - Bodenanschluss Fliesenbelag/ flächiger Anschluss
		Gezeichnet	24.07.2014 jk	
		Kontrolliert		
		Norm		
		Projekt Nr.		Z-Nr: VRS_P60_11_0007
		PRO_XXX		
Status	Änderungen	Datum	Name	<div style="text-align: right; font-size: 24pt; font-weight: bold;">1</div> <div style="text-align: right;">A4</div>

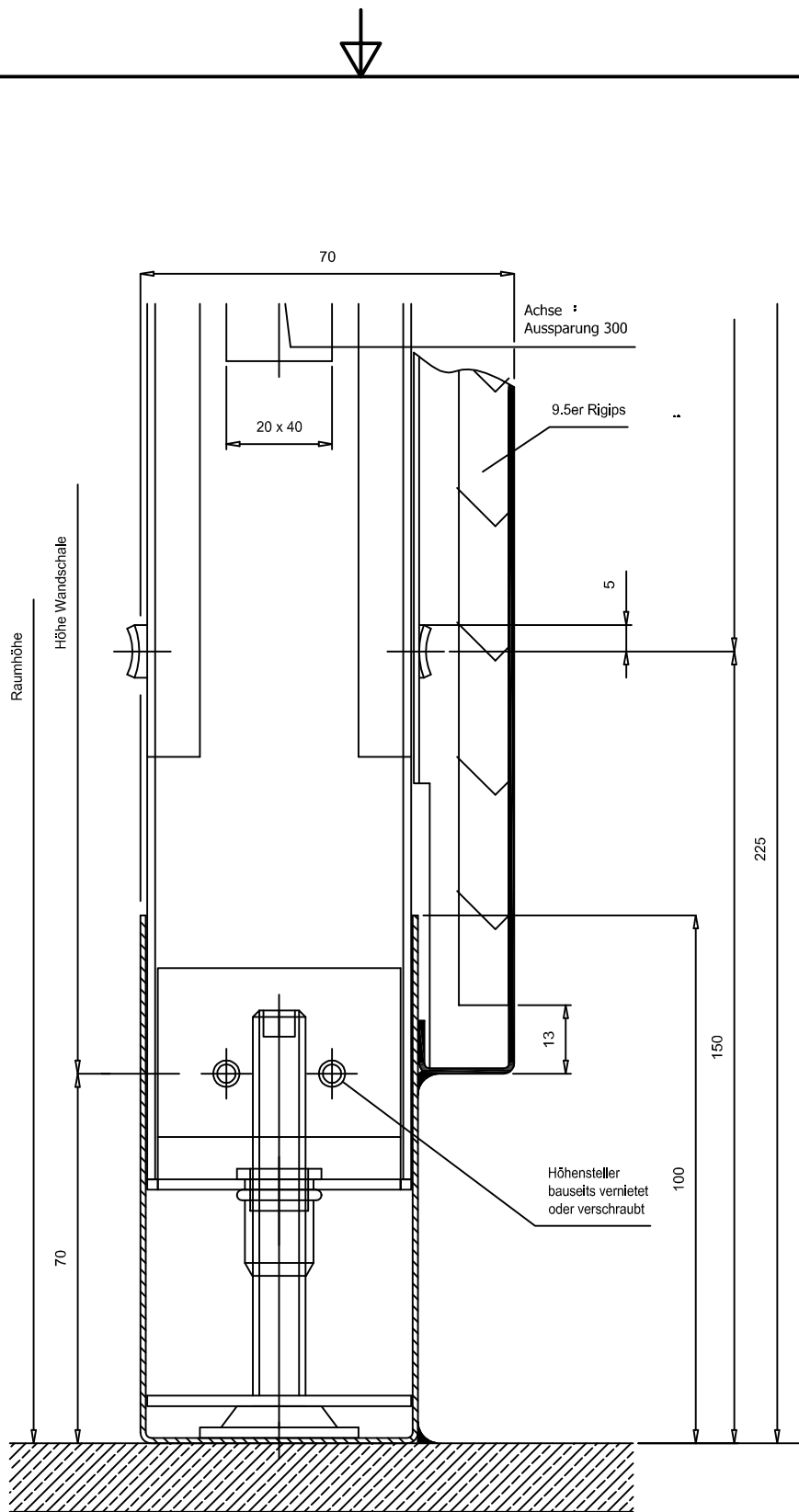

Alle Toleranzen nach DIN ISO 2768 mittel				Material		
This drawing is our literary property and may neither copied nor to be exposed approachable to third persons without our agreement; according to German Copyright Act						
			Datum	Name		Description / Bezeichnung: D 006 C Sockelausbildung halbe Wand Wand - Bodenanschluss
			Gezeichnet	23.07.2014	jk	
			Kontrolliert			
			Norm			
			Projekt Nr.			Z-Nr: VRS_P60_11_0008
			PRO_XXX			
Status	Änderungen	Datum	Name			1 A4

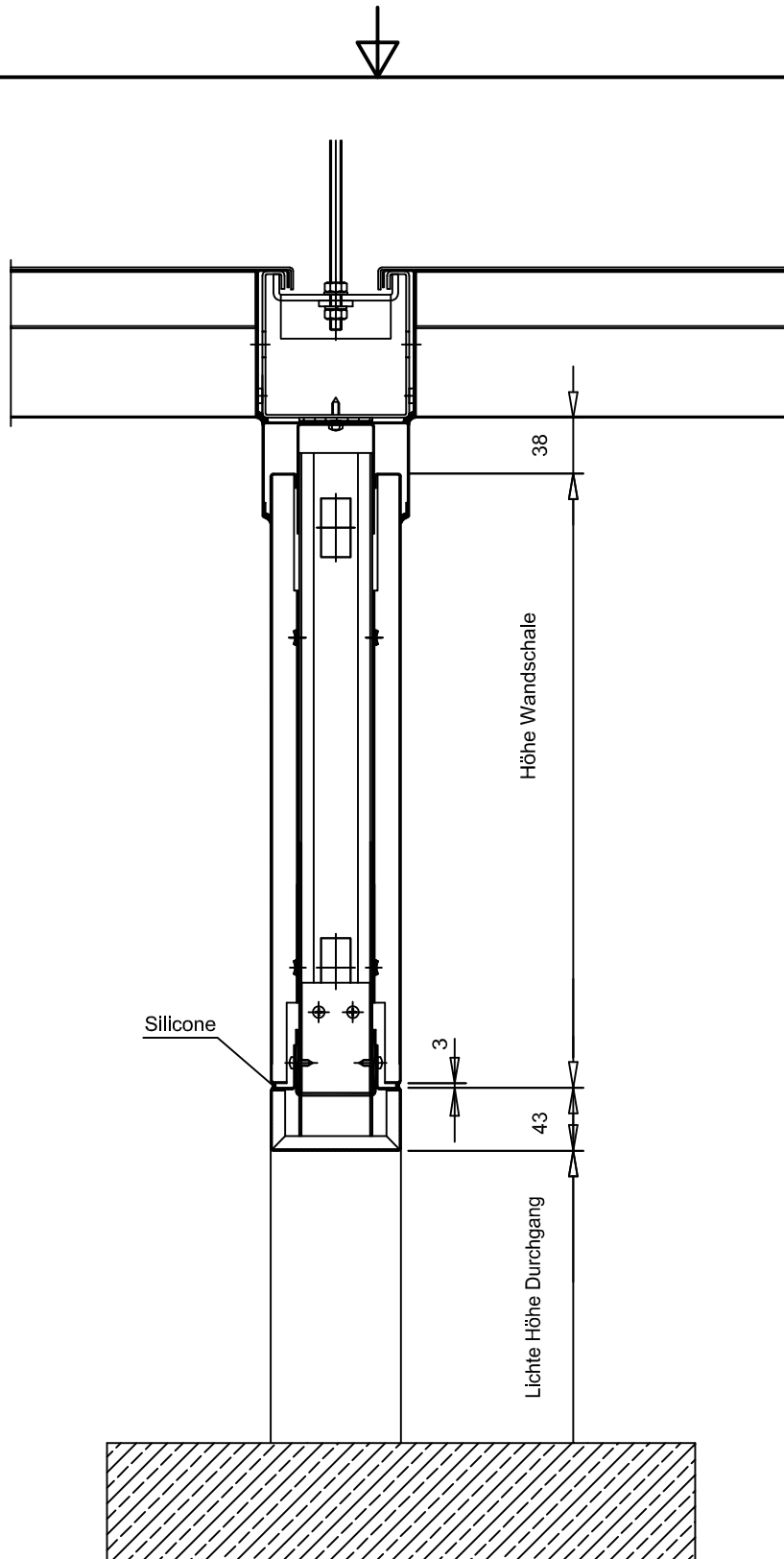

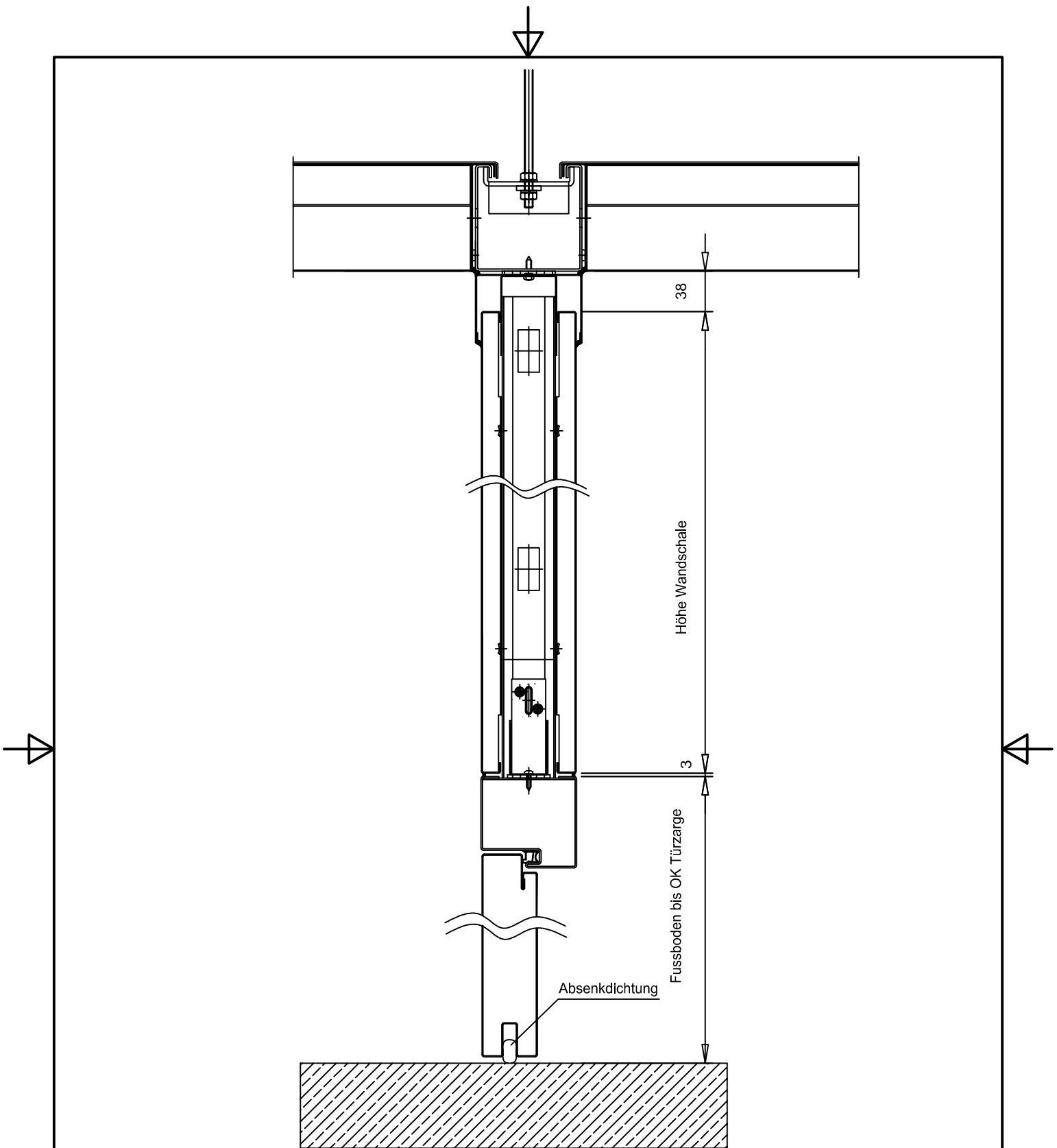

Alle Toleranzen nach DIN ISO 2768 mittel			Material		
This drawing is our literary property and may neither copied nor to be exposed approachable to third persons without our agreement; according to German Copyright Act					
			Datum	Name	Description / Bezeichnung: D 007 Durchgangsverkleidung Vertikalschnitt
			Gezeichnet	24.07.2014 jk	
			Kontrolliert		
			Norm		
			Projekt Nr. PRO_XXX		Z-Nr: VRS_P90_11_0009
					1
					A4
Status	Änderungen	Datum	Name		



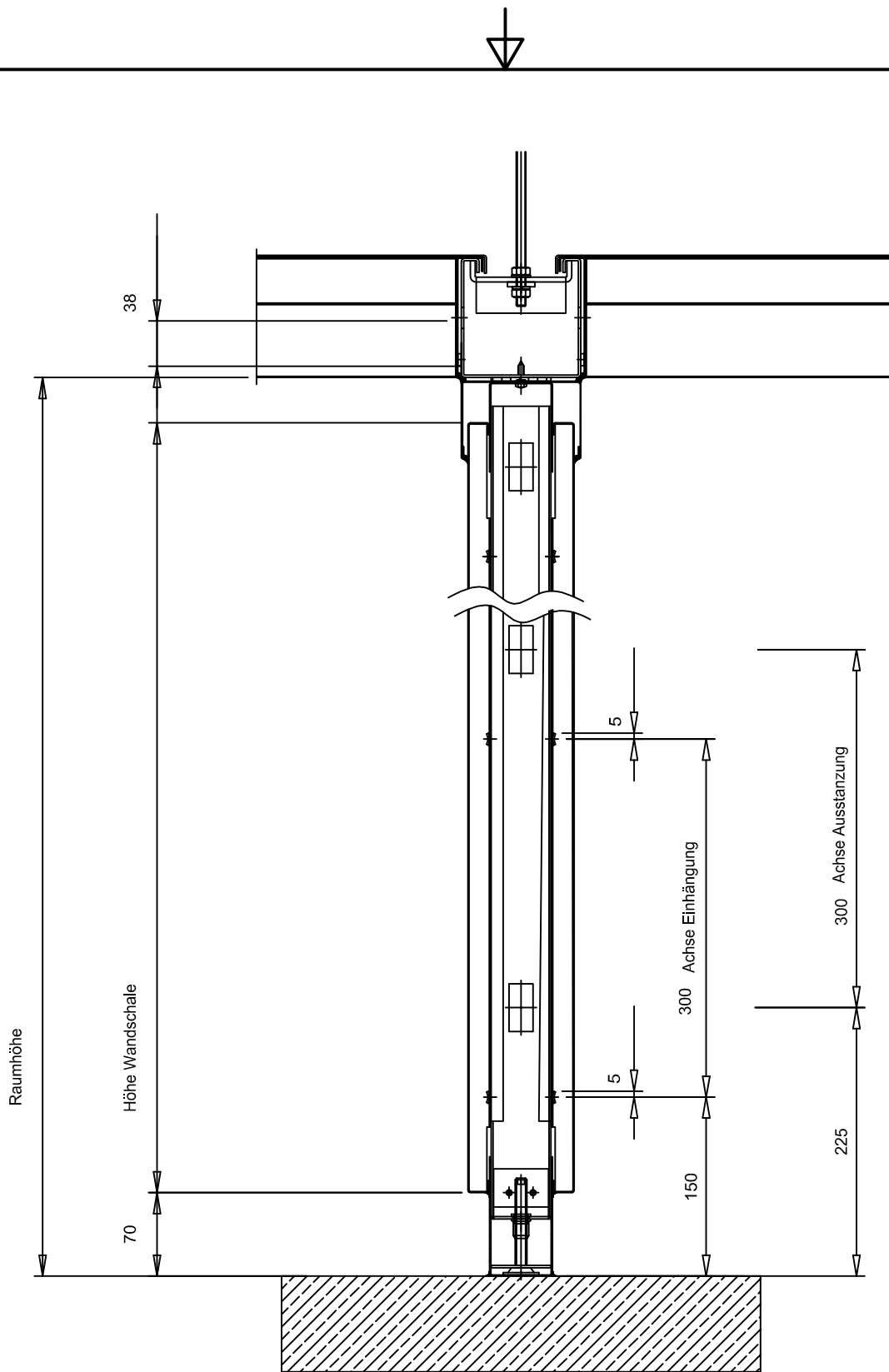

Alle Toleranzen nach DIN ISO 2768 mittel				Material			
This drawing is our literary property and may neither copied nor to be exposed approachable to third persons without our agreement; according to German Copyright Act							
				Datum	Name	Description / Bezeichnung: D 007 B Vertikalschnitt Trennwand Tür	
				Gezeichnet	24.07.2014		jk
				Kontrolliert			
				Norm			
				Projekt Nr. PRO_XXX		Z-Nr: VRS_P90_11_0011	
						1	
						A4	
Status	Änderungen	Datum	Name				





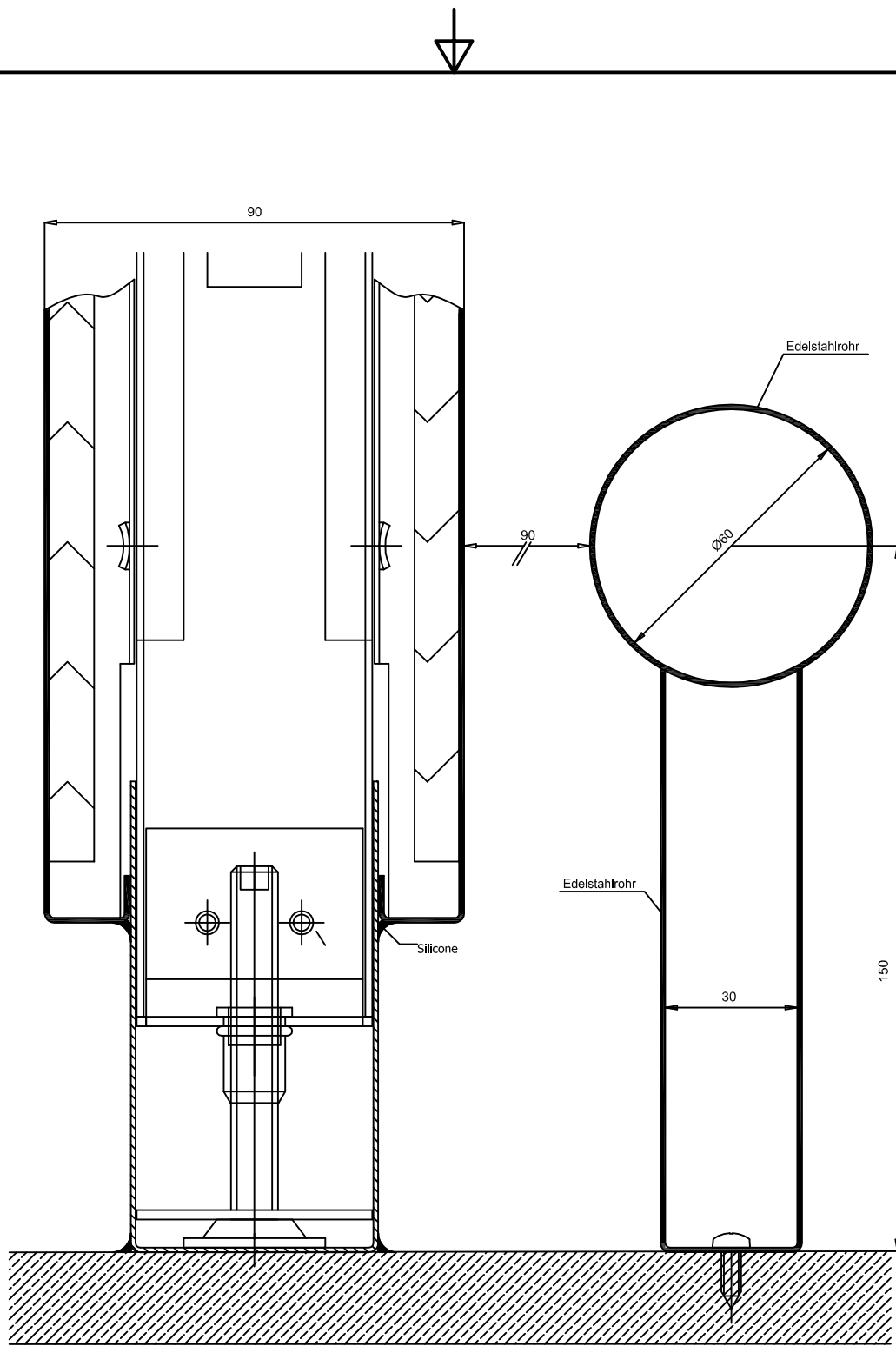

Alle Toleranzen nach DIN ISO 2768 mittel		Material		
<small>This drawing is our literary property and may neither copied nor to be exposed approachable to third persons without our agreement; according to German Copyright Act</small>				
		Datum	Name	Description / Bezeichnung: D 007 C Vertikalschnitt Trennwand Voll
		Gezeichnet	24.07.2014 jk	
		Kontrolliert		
		Norm		
		Projekt Nr.		Z-Nr: VRS_P90_11_0012
		PRO_XXX		
Status	Änderungen	Datum	Name	<div style="text-align: right; font-size: 24pt; font-weight: bold;">1</div> <div style="text-align: right;">A4</div>

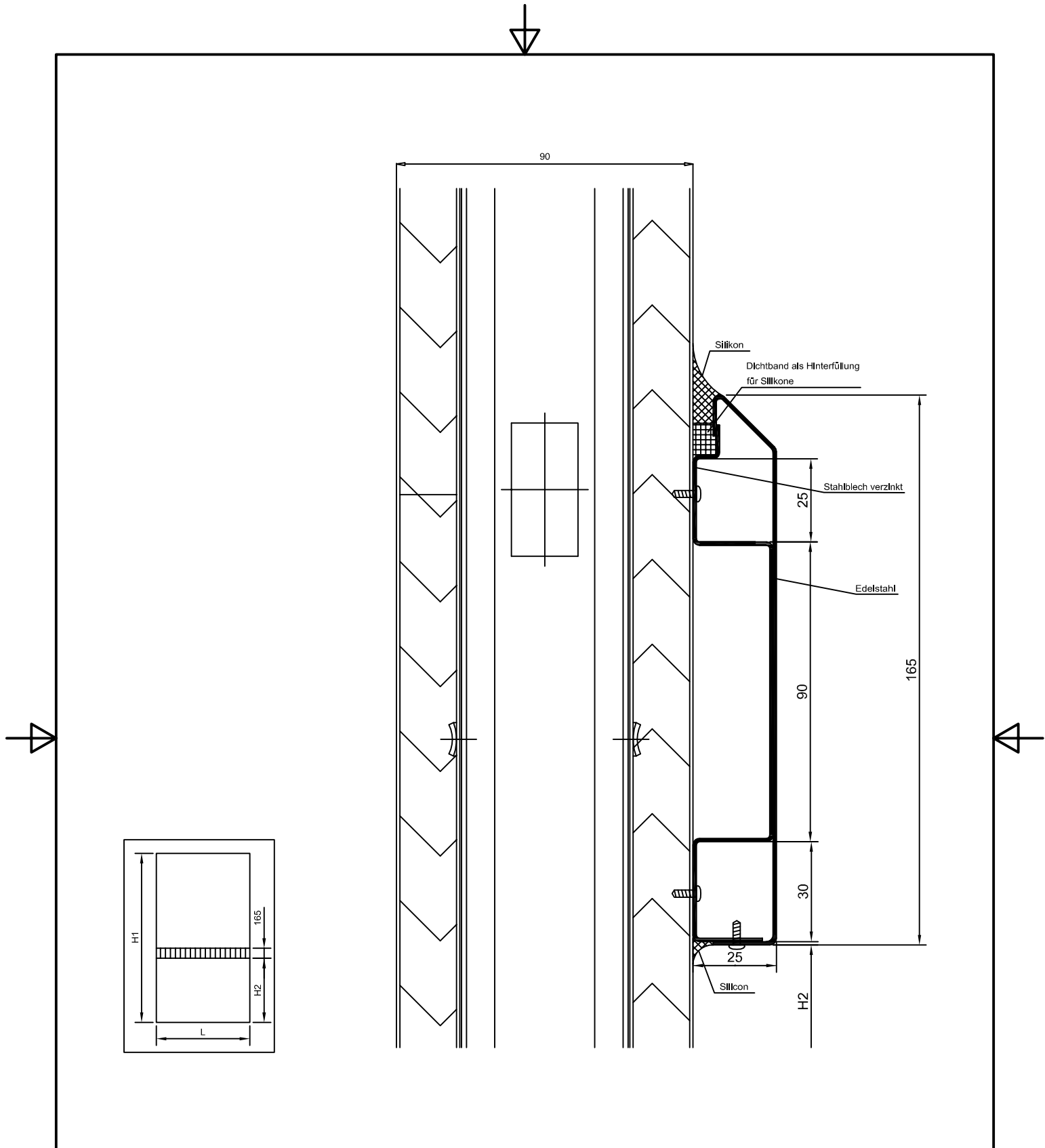

Alle Toleranzen nach DIN ISO 2768 mittel		Material		
<small>This drawing is our literary property and may neither copied nor to be exposed approachable to third persons without our agreement; according to German Copyright Act</small>				
		Datum	Name	Description / Bezeichnung: D 008 RammschutzFreistehend
		Gezeichnet	25.07.2014 jk	
		Kontrolliert		
		Norm		
		Projekt Nr. PRO_XXX		Z-Nr: VRS_P90_11_0013
Status	Änderungen	Datum	Name	1 A4



Alle Toleranzen nach DIN ISO 2768 mittel		Material		
This drawing is our literary property and may neither copied nor to be exposed approachable to third persons without our agreement; according to German Copyright Act				
		Datum	Name	Description / Bezeichnung: D 008 A Schrammschutz
		Gezeichnet	25.07.2014 jk	
		Kontrolliert		
		Norm		
		Projekt Nr. PRO_XXX		Z-Nr: VRS_P90_11_0014
Status	Änderungen	Datum	Name	1 A4

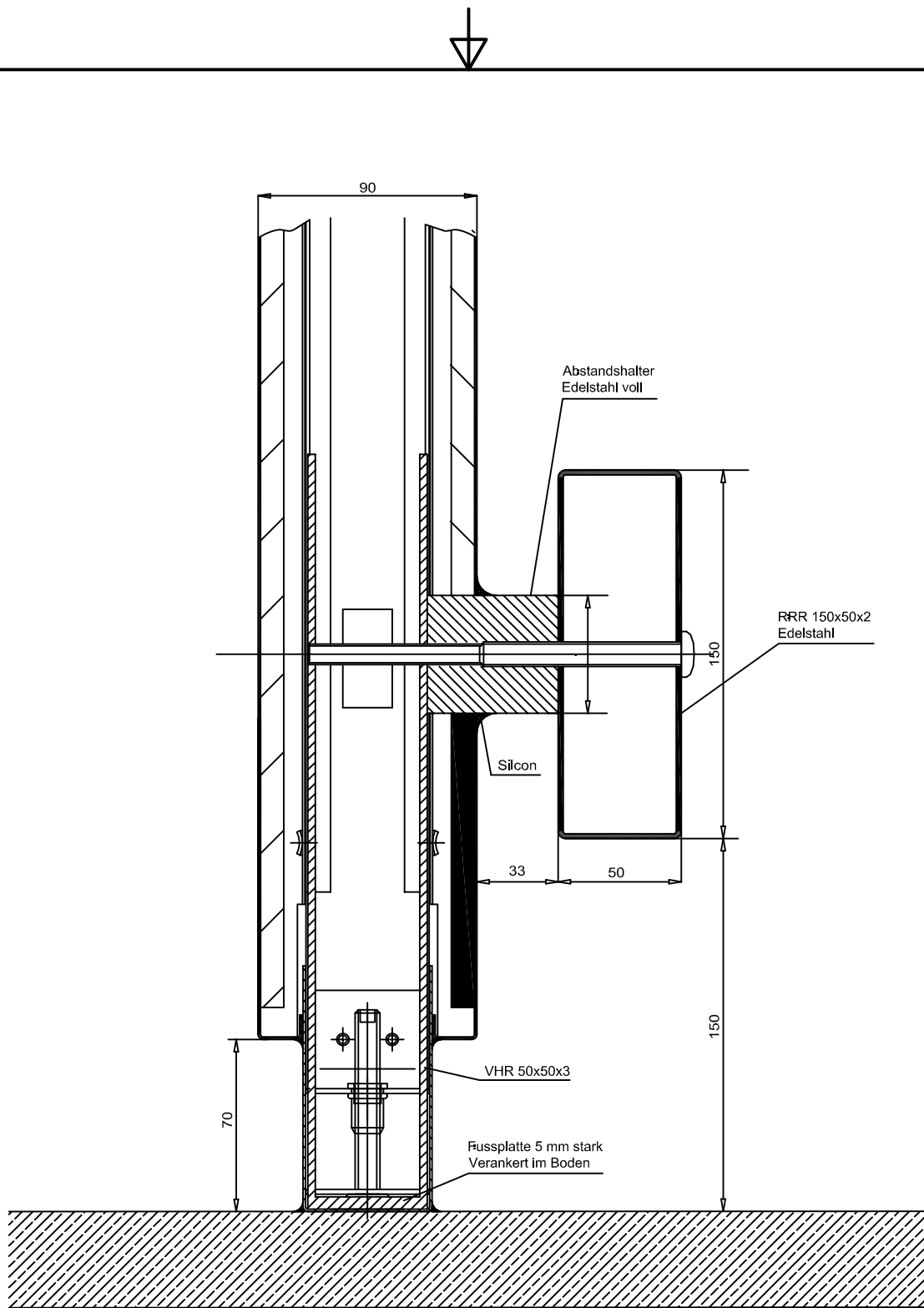

Alle Toleranzen nach DIN ISO 2768 mittel		Material		
This drawing is our literary property and may neither copied nor to be exposed approachable to third persons without our agreement; according to German Copyright Act				
		Datum	Name	Description / Bezeichnung: D 008 B Rammschutz an Reinraumwand
		Gezeichnet	25.07.2014 jk	
		Kontrolliert		
		Norm		
		Projekt Nr. PRO_XXX		Z-Nr: VRS_P90_11_0015
Status	Änderungen	Datum	Name	1 A4

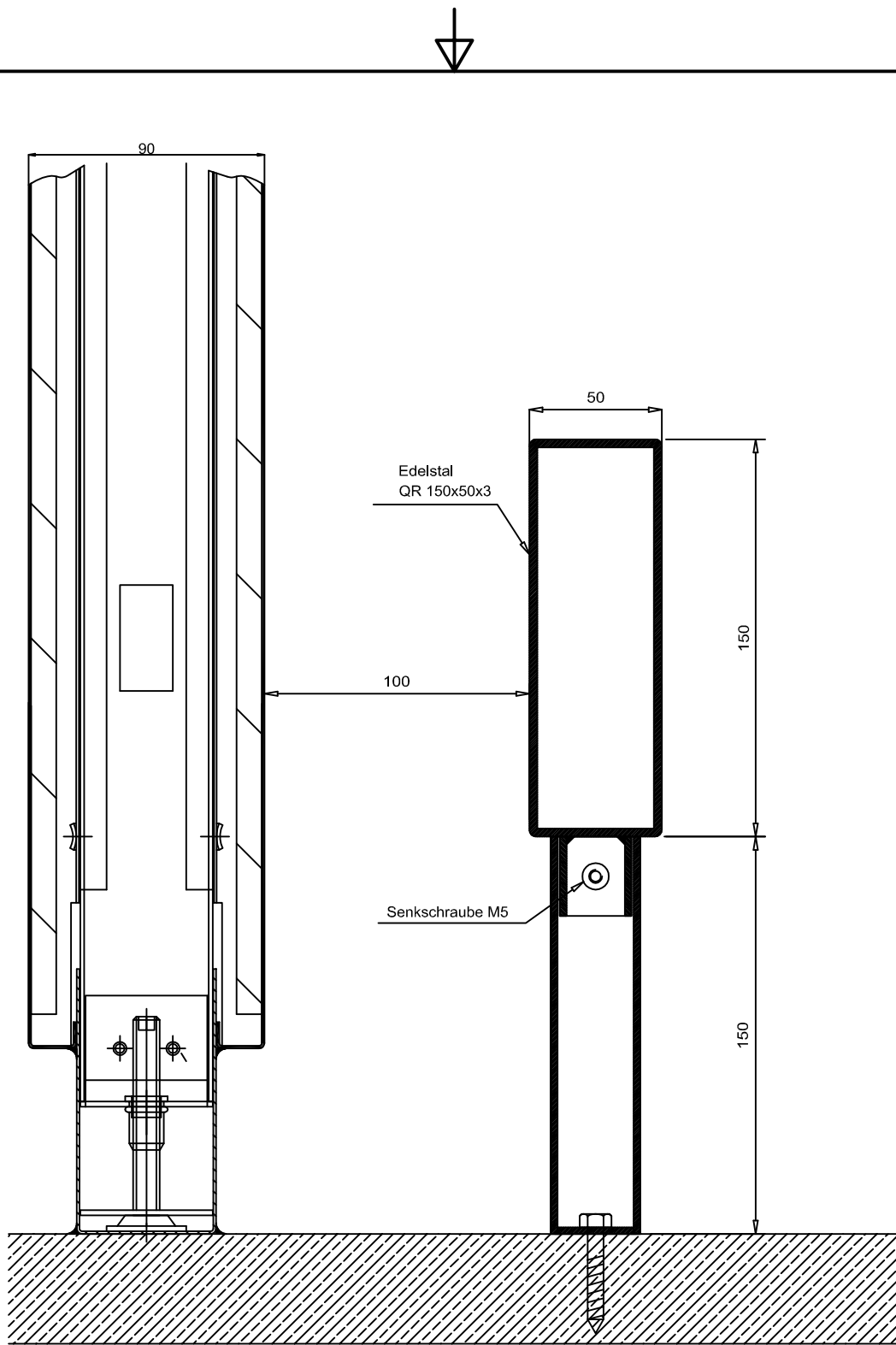

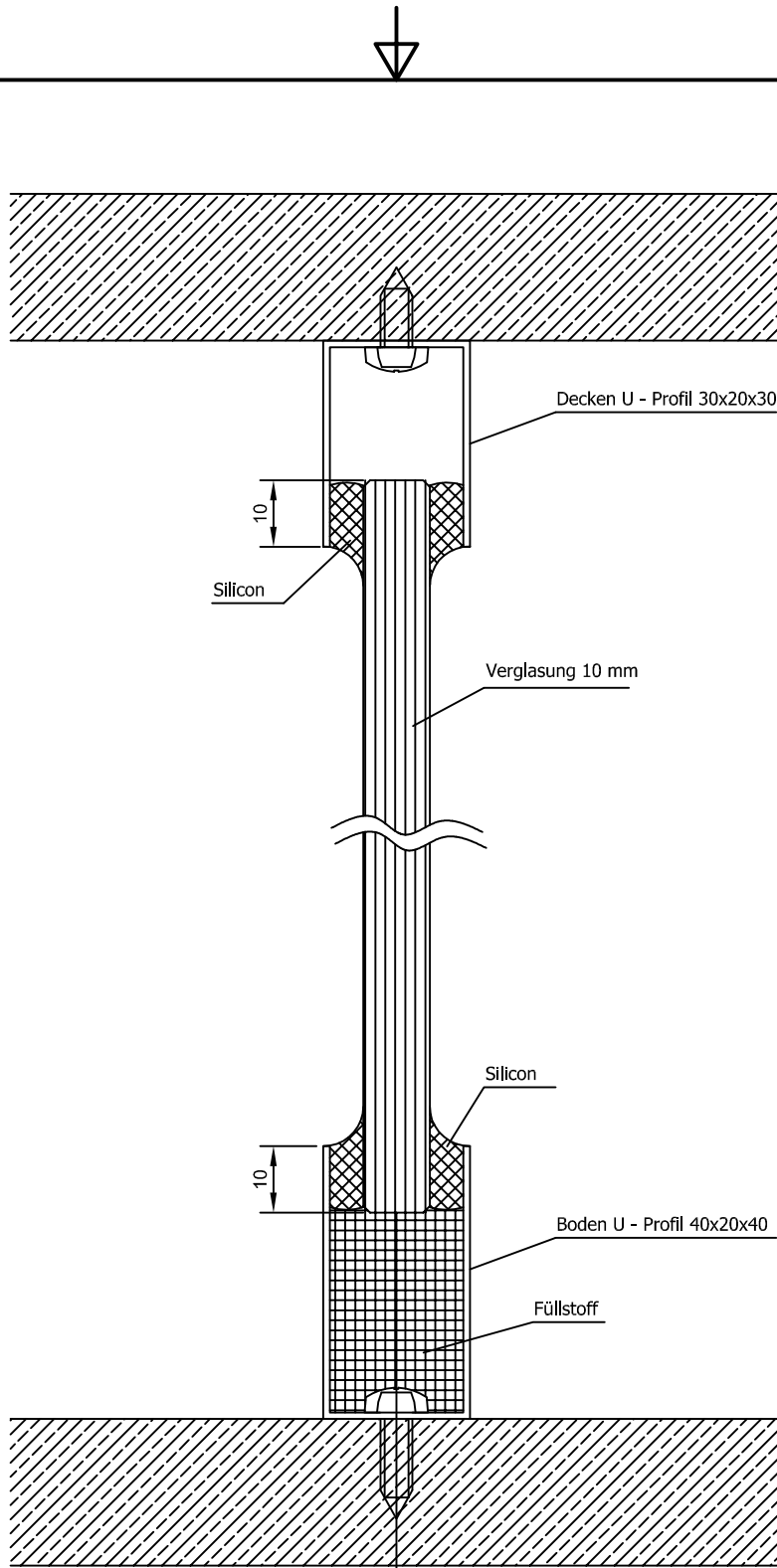

Alle Toleranzen nach DIN ISO 2768 mittel				Material		
This drawing is our literary property and may neither copied nor to be exposed approachable to third persons without our agreement; according to German Copyright Act						
			Datum	Name		Description / Bezeichnung: D 008 C Rammschutz freistehend rechteckig
			Gezeichnet	25.07.2014	jk	
			Kontrolliert			
			Norm			
			Projekt Nr.			Z-Nr: VRS_P90_11_0016
			PRO_XXX			
Status	Änderungen	Datum	Name			1 A4

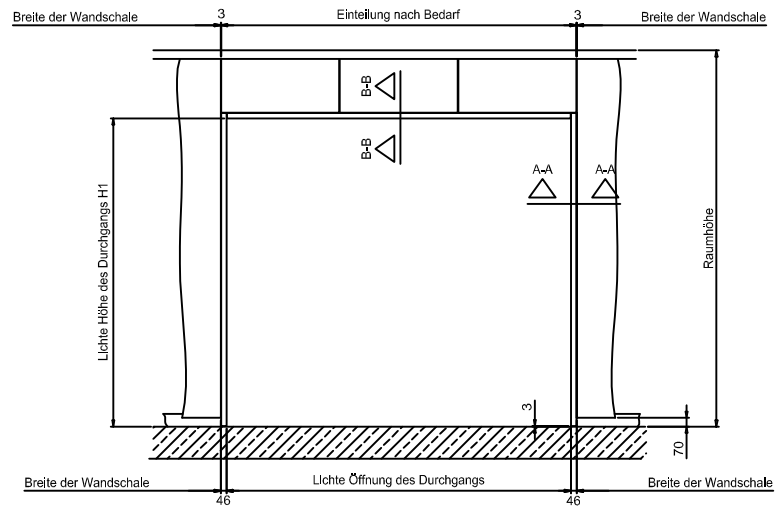
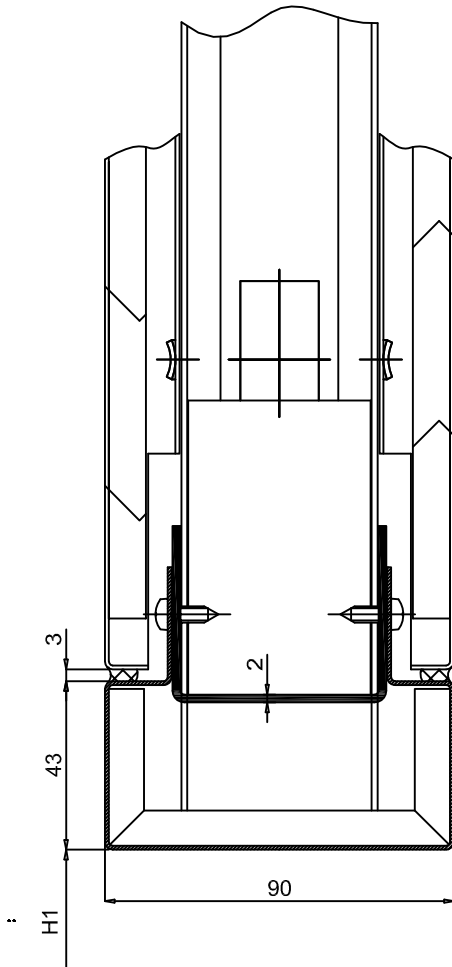

Alle Toleranzen nach DIN ISO 2768 mittel			Material		
This drawing is our literary property and may neither copied nor to be exposed approachable to third persons without our agreement; according to German Copyright Act					
			Datum	Name	Description / Bezeichnung: D 009 Glaswand
			Gezeichnet	25.07.2014 jk	
			Kontrolliert		
			Norm		
			Projekt Nr. PRO_XXX		Z-Nr: VRS_P90_11_0017
					1
					A4
Status	Änderungen	Datum	Name		

Schnitt B-B



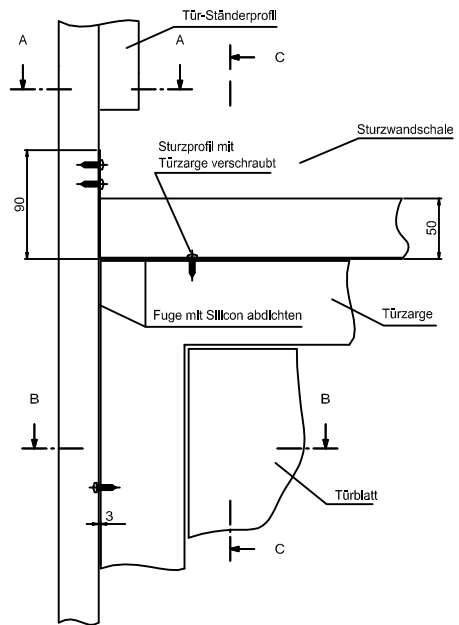
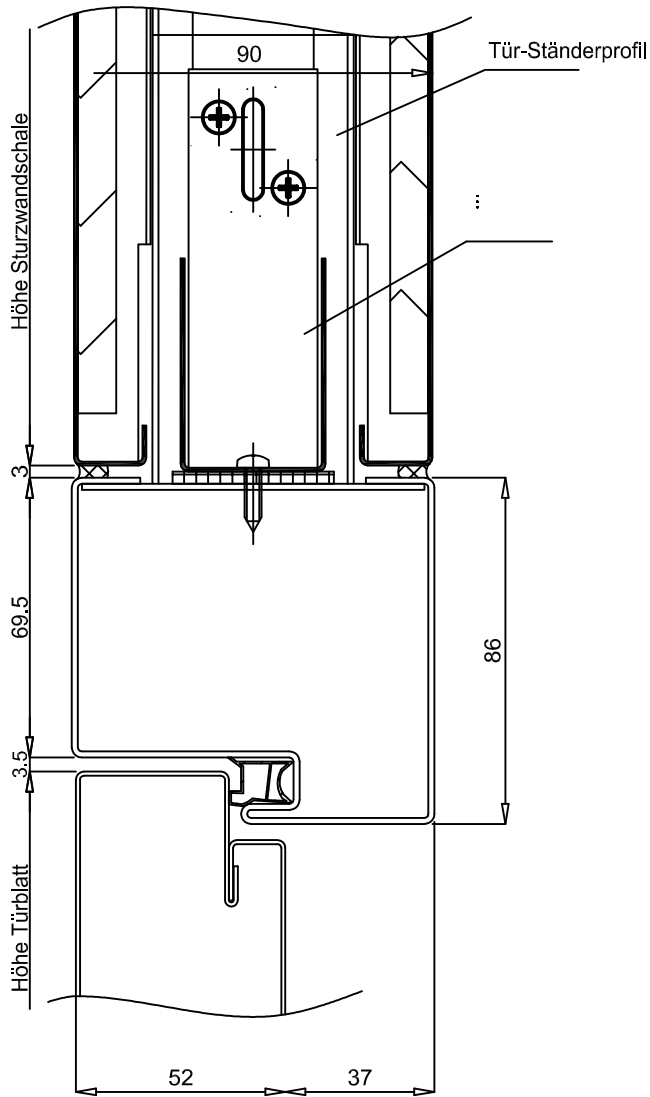

Alle Toleranzen nach DIN ISO 2768 mittel				Material		
This drawing is our literary property and may neither copied nor to be exposed approachable to third persons without our agreement; according to German Copyright Act						
				Datum	Name	Description / Bezeichnung: D 010 Durchgangszarge
				Gezeichnet	25.07.2014 jk	
				Kontrolliert		
				Norm		
				Projekt Nr. PRO_XXX		Z-Nr: VRS_P90_11_0018
						1
						A4
Status	Änderungen	Datum	Name			

Schnitt C-C

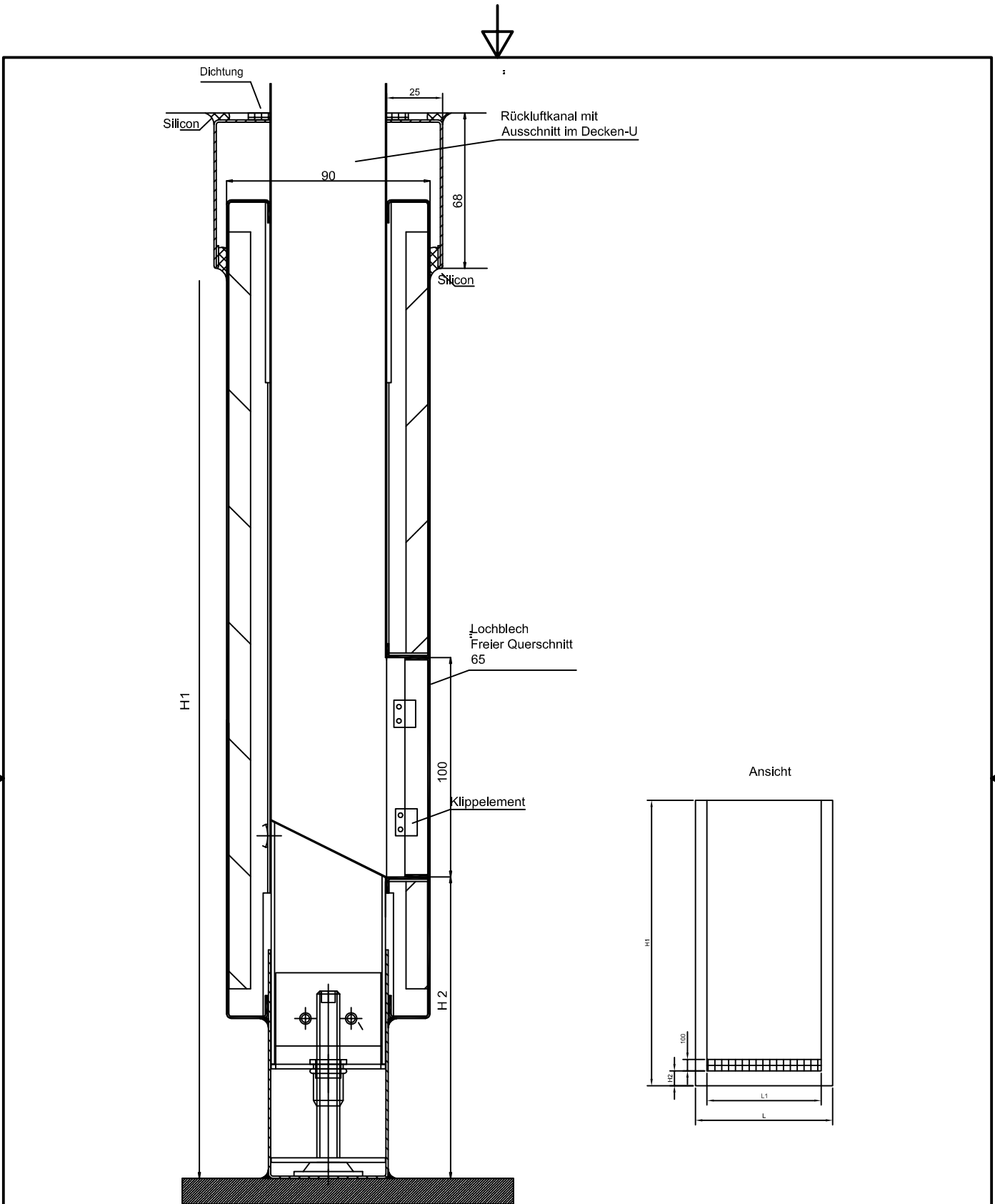

Alle Toleranzen nach DIN ISO 2768 mittel			Material		
This drawing is our literary property and may neither copied nor to be exposed approachable to third persons without our agreement; according to German Copyright Act					
			Datum	Name	Description / Bezeichnung: D 012 Türanschluss an Vollwand
			Gezeichnet	25.07.2014 jk	
			Kontrolliert		
			Norm		
			Projekt Nr. PRO_XXX		Z-Nr: VRS_P90_11_0019
Status	Änderungen	Datum	Name		1 A4



Alle Toleranzen nach DIN ISO 2768 mittel				Material			
This drawing is our literary property and may neither copied nor to be exposed approachable to third persons without our agreement; according to German Copyright Act							
				Datum	Name	Description / Bezeichnung: D 013 Rücklaufschacht integriert	
			Gezeichnet	25.07.2014	jk		
			Kontrolliert				
			Norm				
			Projekt Nr. PRO_XXX			Z-Nr: VRS_P90_11_0020	1
Status	Änderungen	Datum	Name			A4	

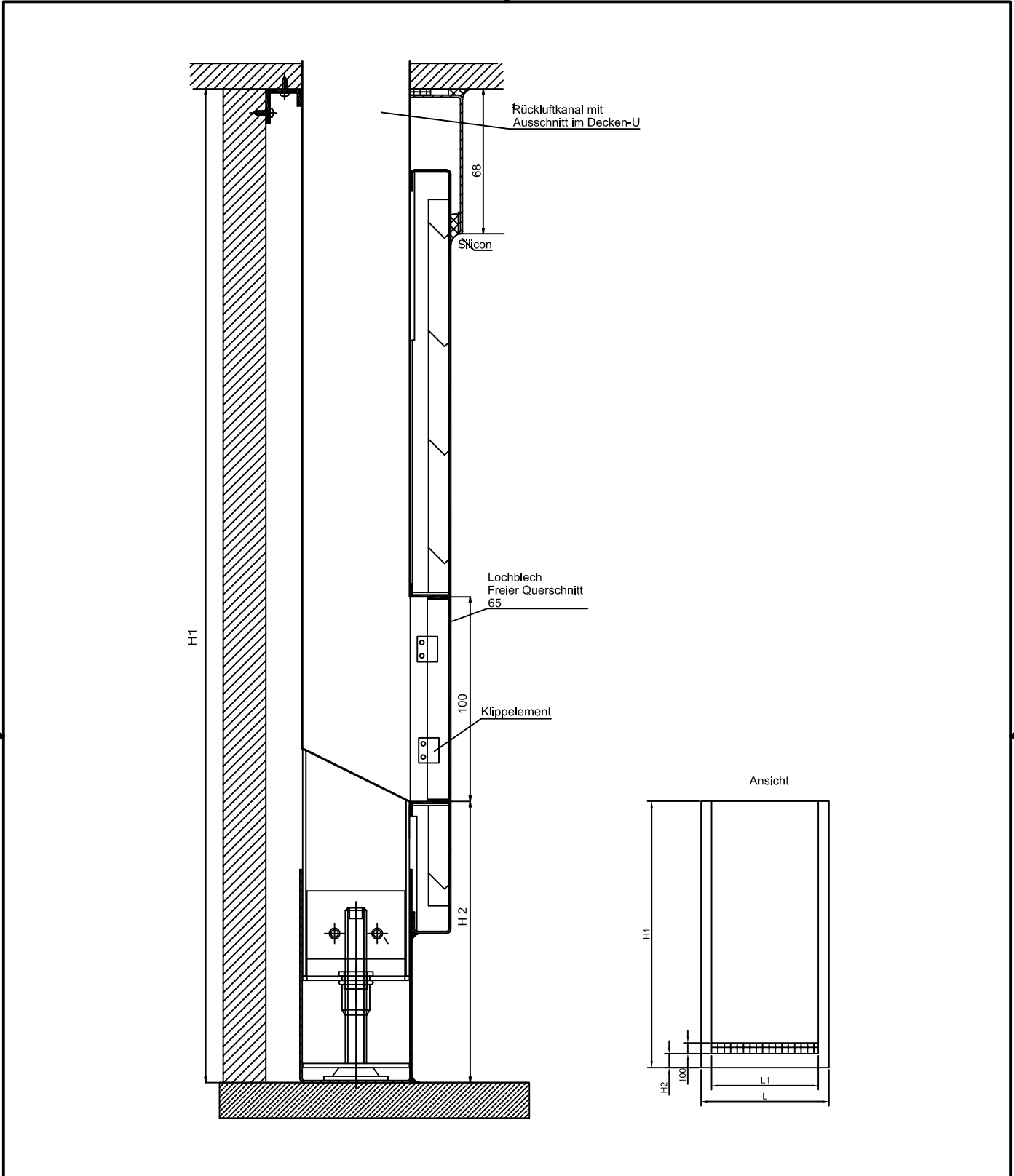

Alle Toleranzen nach DIN ISO 2768 mittel				Material			
This drawing is our literary property and may neither copied nor to be exposed approachable to third persons without our agreement; according to German Copyright Act							
				Datum	Name	Description / Bezeichnung: D 013 A Rücklaufschacht integriert mit Wandverkelidung	
				Gezeichnet	25.07.2014		jk
				Kontrolliert			
				Norm			
				Projekt Nr. PRO_XXX		Z-Nr: VRS_P90_11_0021	
						1	
						A4	
Status	Änderungen	Datum	Name				

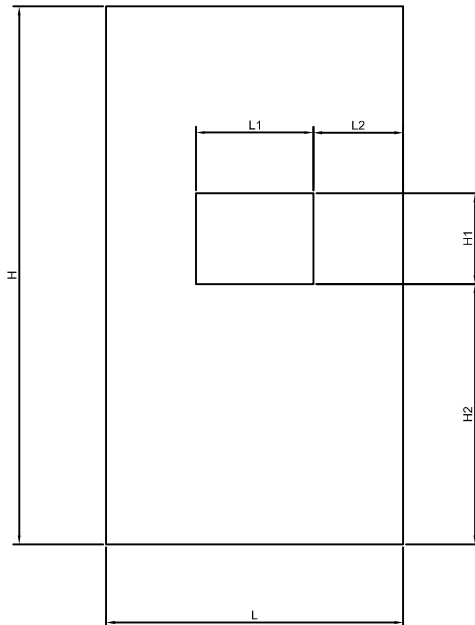
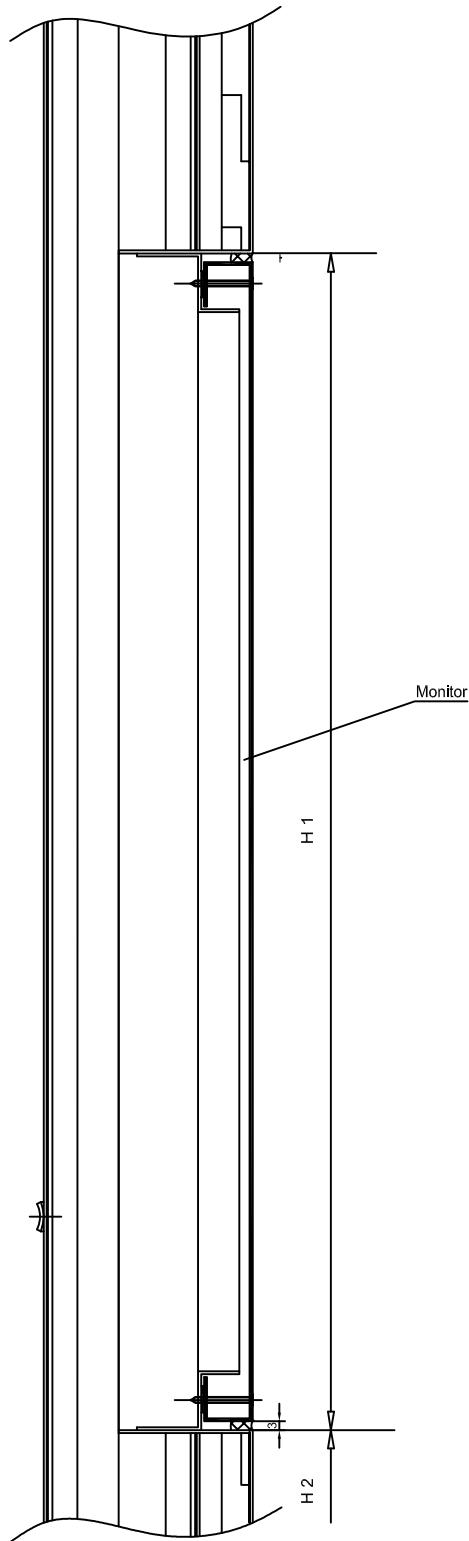

Alle Toleranzen nach DIN ISO 2768 mittel				Material		
This drawing is our literary property and may neither copied nor to be exposed approachable to third persons without our agreement; according to German Copyright Act						
			Datum	Name		Description / Bezeichnung: D 013 B Installation Trennwand halb
			Gezeichnet	25.07.2014	jk	
			Kontrolliert			
			Norm			
			Projekt Nr.		Z-Nr: VRS_P90_11_0022	1
			PRO_XXX			
Status	Änderungen	Datum	Name			

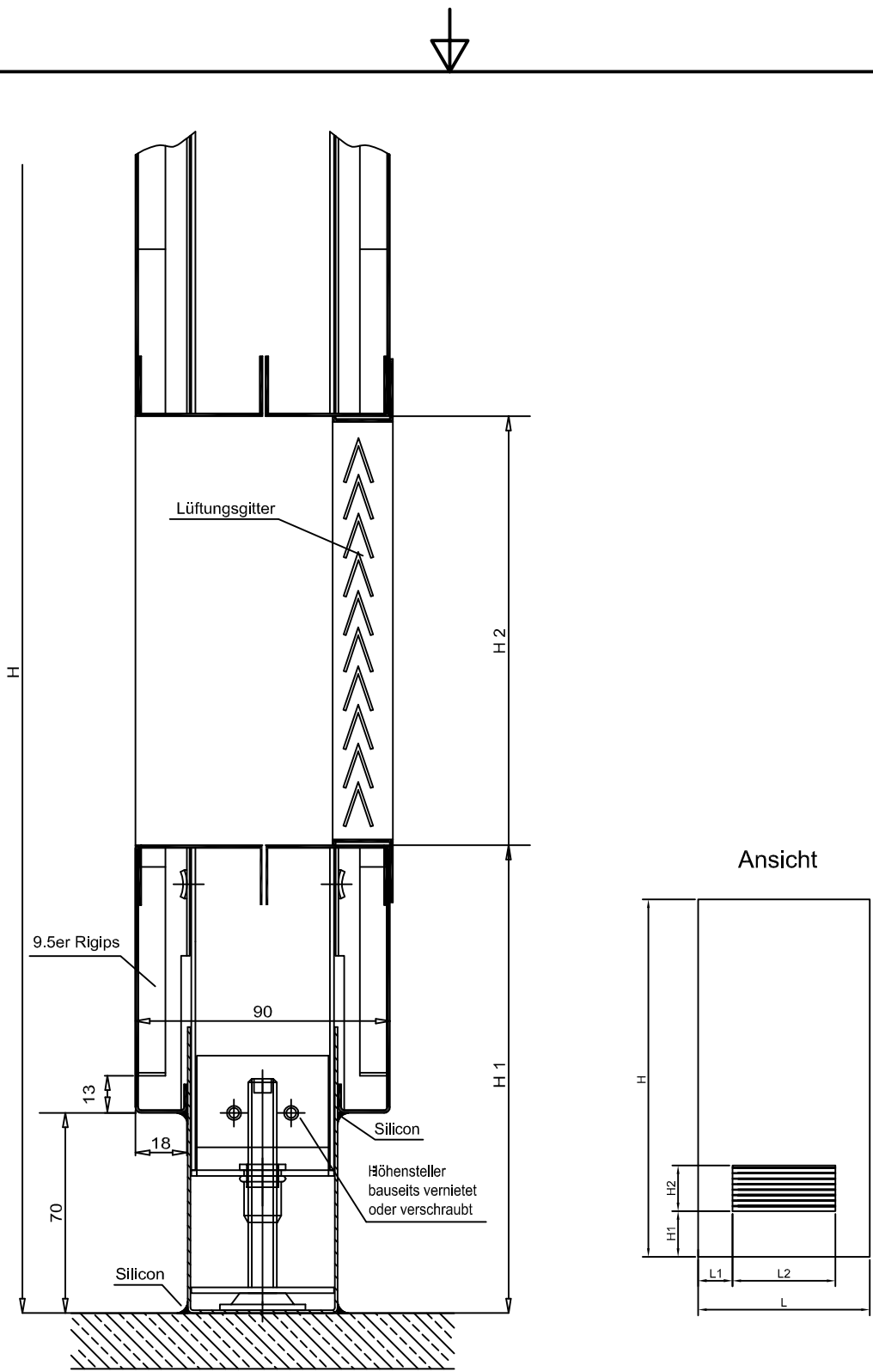

Alle Toleranzen nach DIN ISO 2768 mittel				Material			
This drawing is our literary property and may neither copied nor to be exposed approachable to third persons without our agreement; according to German Copyright Act							
			Datum	Name		Description / Bezeichnung: D 013 C Lüftungsgitter übergreifend	
			Gezeichnet	25.07.2014	jk		
			Kontrolliert				
			Norm				
			Projekt Nr. PRO_XXX			Z-Nr: VRS_P90_11_0023	1
Status	Änderungen	Datum	Name			A4	



Schnitt B-B

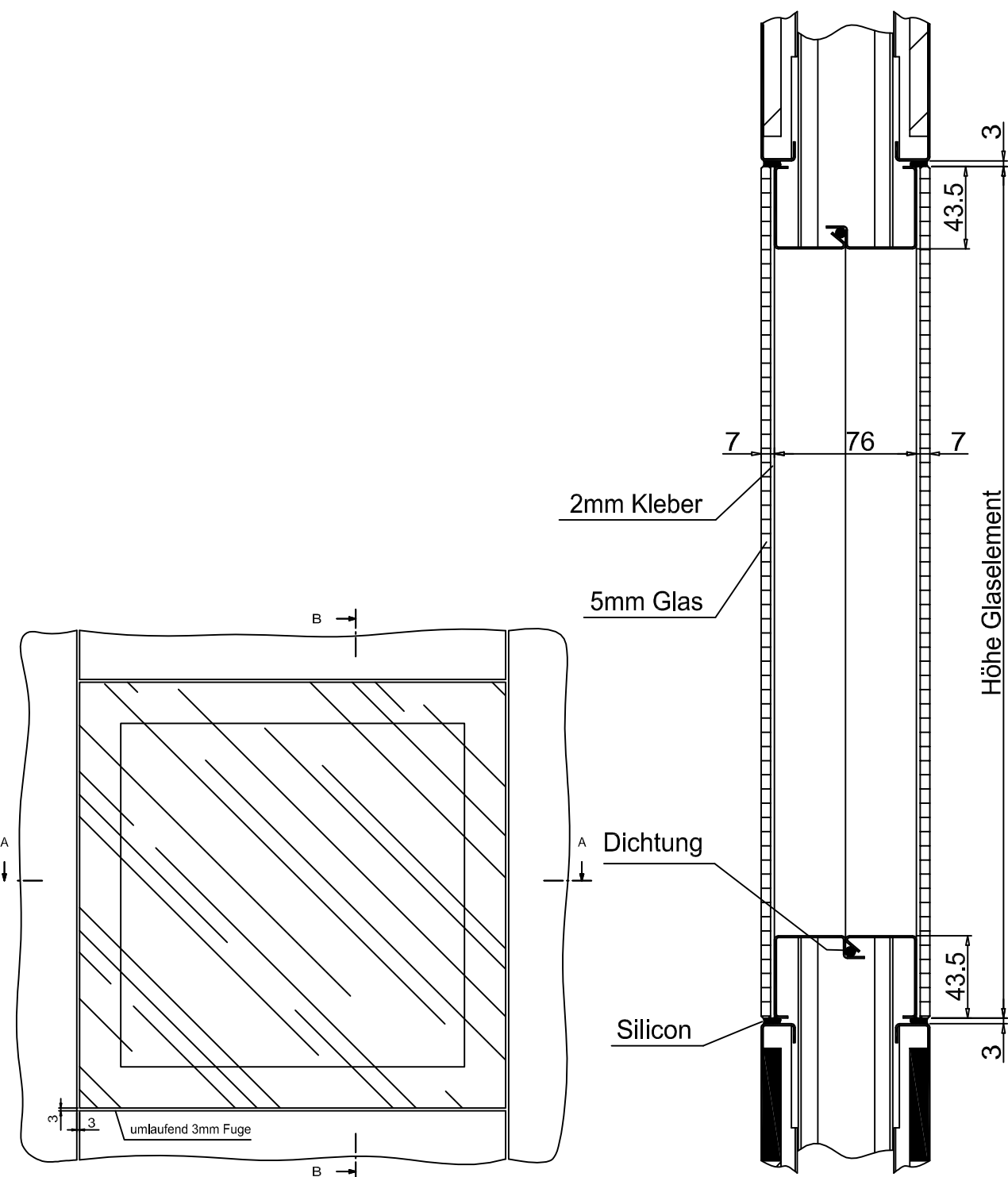

Alle Toleranzen nach DIN ISO 2768 mittel				Material	
This drawing is our literary property and may neither copied nor to be exposed approachable to third persons without our agreement; according to German Copyright Act					
			Datum	Name	
			Gezeichnet	25-07-2014	jk
			Kontrolliert		
			Norm		
			Projekt Nr.		
			PRO_XXX		
Status	Änderungen	Datum	Name		





Description / Bezeichnung:
D 014 A Trennwandverglasung

Z-Nr: VRS_P90_11_0024

1
A4

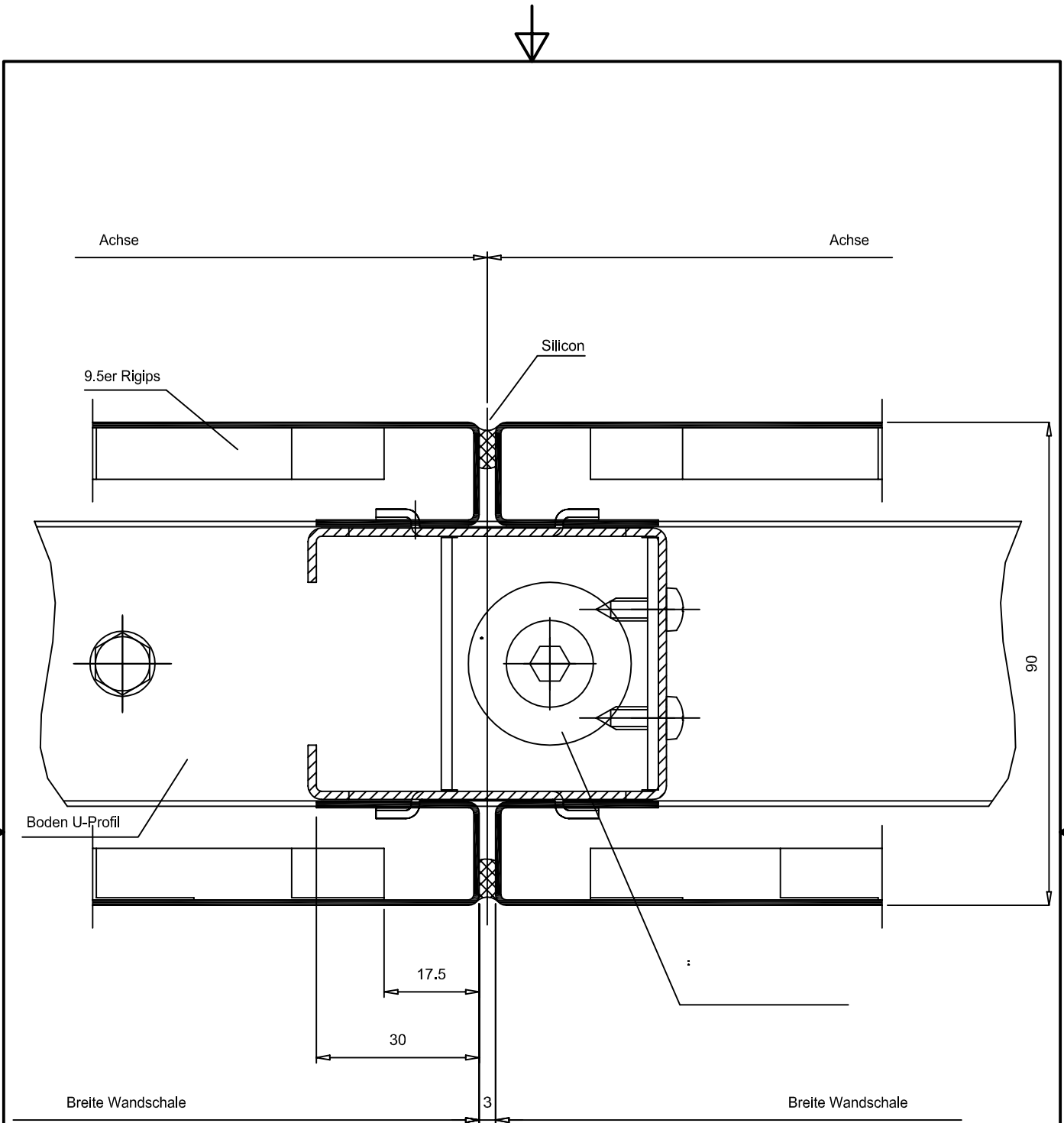



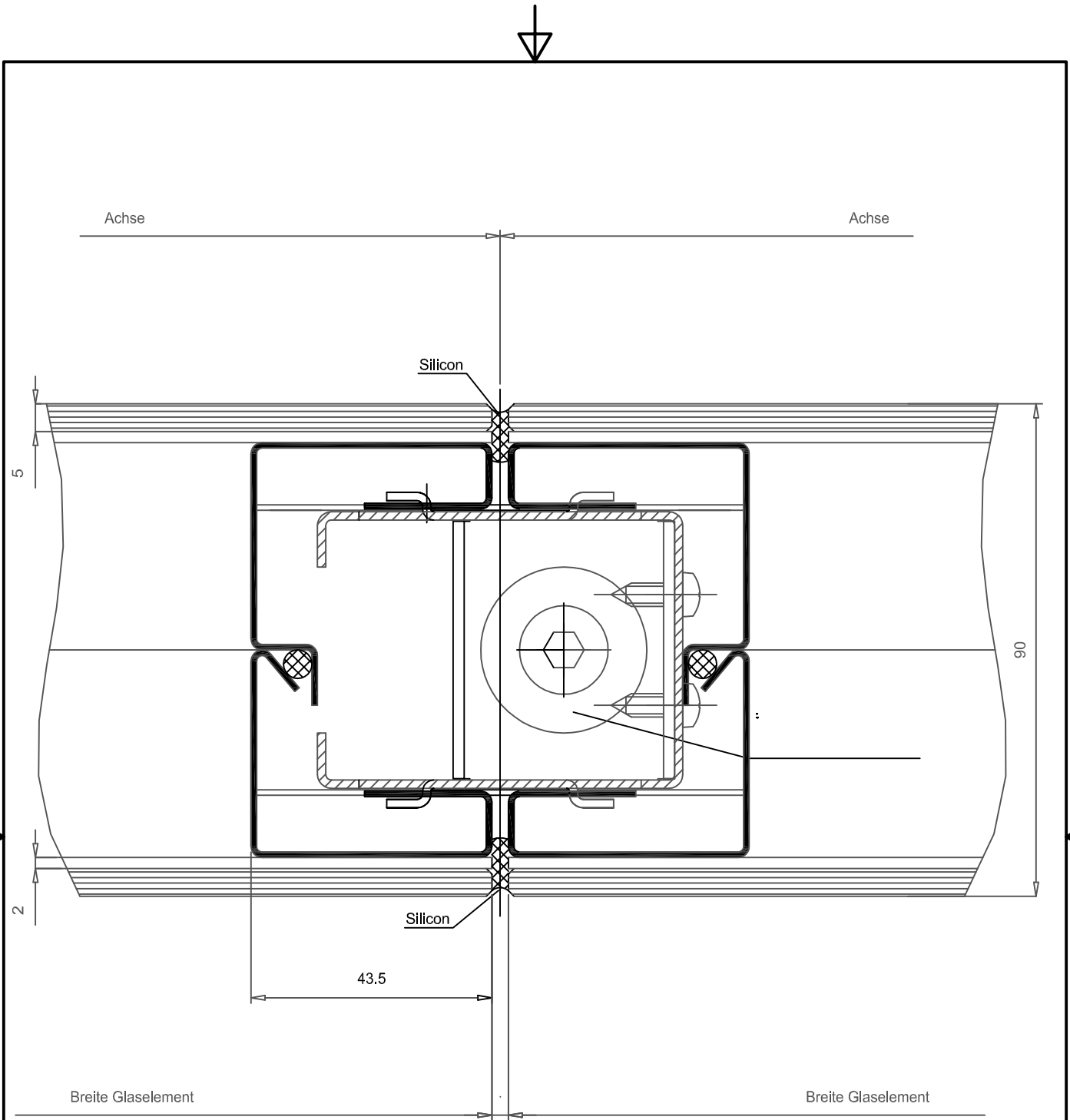

Alle Toleranzen nach DIN ISO 2768 mittel				Material		
This drawing is our literary property and may neither copied nor to be exposed approachable to third persons without our agreement; according to German Copyright Act						
			Datum	Name		Description / Bezeichnung: D 001 Trennwand voll
			Gezeichnet	16.07.2014	jk	
			Kontrolliert			
			Norm			
			Projekt Nr.		Z-Nr: VRS_P90_12_0001	1
			PRO_XXX			
Status	Änderungen	Datum	Name			

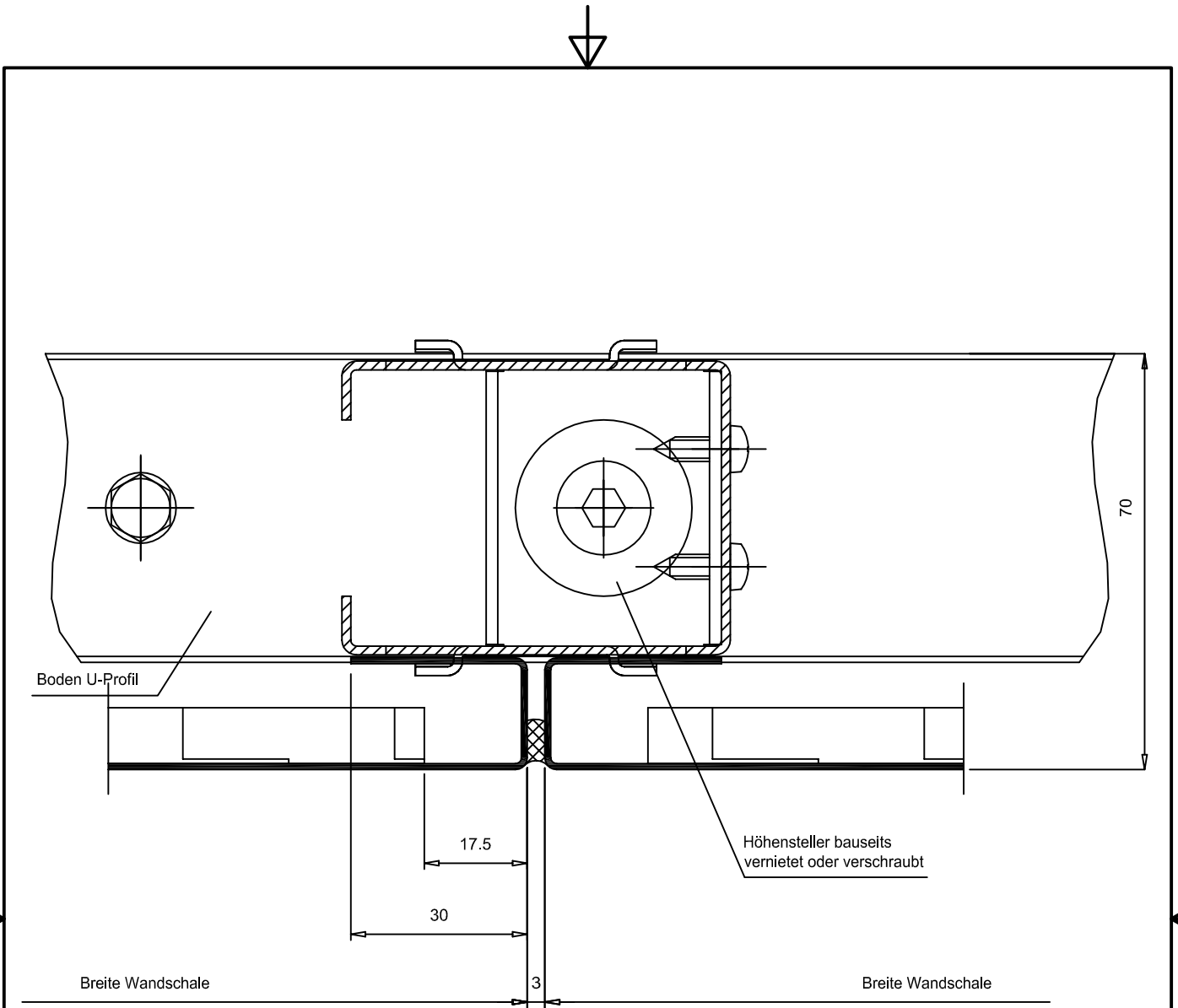

Alle Toleranzen nach DIN ISO 2768 mittel				Material			
This drawing is our literary property and may neither copied nor to be exposed approachable to third persons without our agreement; according to German Copyright Act							
				Datum	Name	Description / Bezeichnung: D 001A Trennwand zweifach Verglasung	
				Gezeichnet	16.07.2014		jk
				Kontrolliert			
				Norm			
				Projekt Nr. PRO_XXX		Z-Nr: VRS_P90_12_0002	
						1	
						A4	
Status	Änderungen	Datum	Name				



Alle Toleranzen nach DIN ISO 2768 mittel			Material			
This drawing is our literary property and may neither copied nor to be exposed approachable to third persons without our agreement; according to German Copyright Act						
			Datum	Name	Description / Bezeichnung: D 001 B Trennwand halb	
			Gezeichnet	16.07.2014		jk
			Kontrolliert			
			Norm			
			Projekt Nr. PRO_XXX		Z-Nr: VRS_P90_12_0003	1
						A4
Status	Änderungen	Datum	Name			

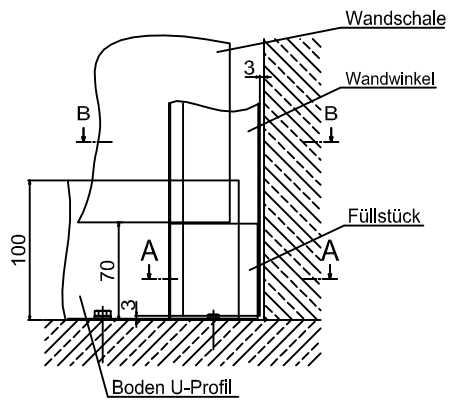

Schnitt A-A

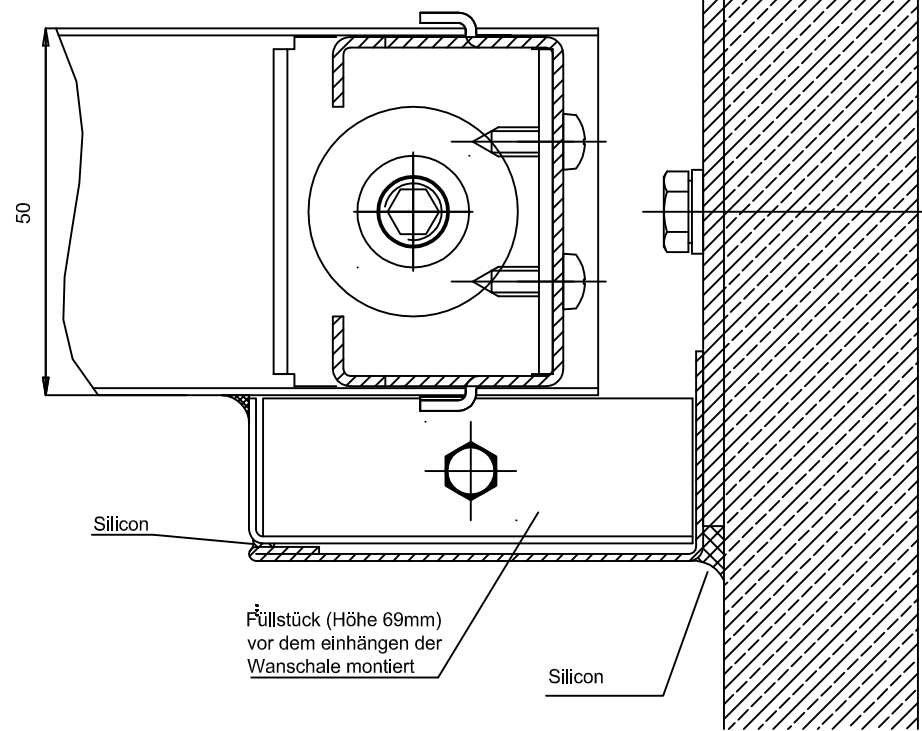

Alle Toleranzen nach DIN ISO 2768 mittel				Material			
This drawing is our literary property and may neither copied nor to be exposed approachable to third persons without our agreement; according to German Copyright Act							
				Datum	Name	Description / Bezeichnung: D 002 Wandanschluss Trennwand halb	
				Gezeichnet	23.07.2014		jk
				Kontrolliert			
				Norm			
				Projekt Nr. PRO_XXX		Z-Nr: VRS_P90_12_0004	
Status	Änderungen	Datum	Name			1 A4	



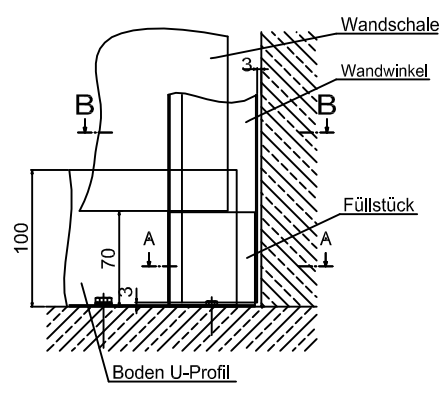

Schnitt B-B

nach dem Einhängen der Wandschale wird der Wandwinkel auf den Blechstreifen geklebt

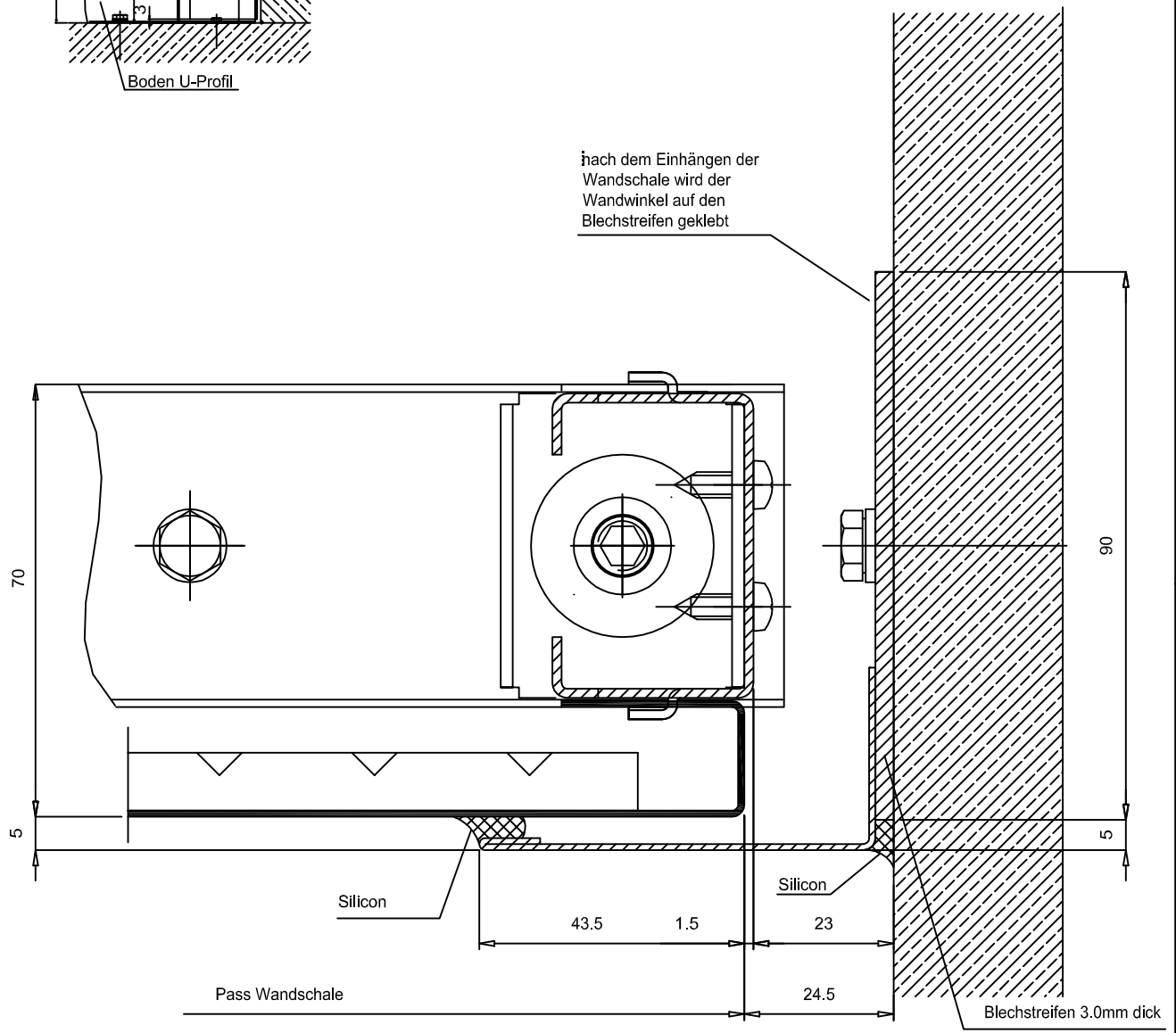

Alle Toleranzen nach DIN ISO 2768 mittel		Material			
<small>This drawing is our literary property and may neither copied nor to be exposed approachable to third persons without our agreement; according to German Copyright Act</small>					
		Datum	Name		D 002 A Wandanschluss Trennwand halb
		Gezeichnet	23.07.2014 jk		
		Kontrolliert			
		Norm			Z-Nr: VRS_P90_12_0005
		Projekt Nr.	PRO_XXX		
Status	Änderungen	Datum	Name	1 A4	



Schnitt A-A

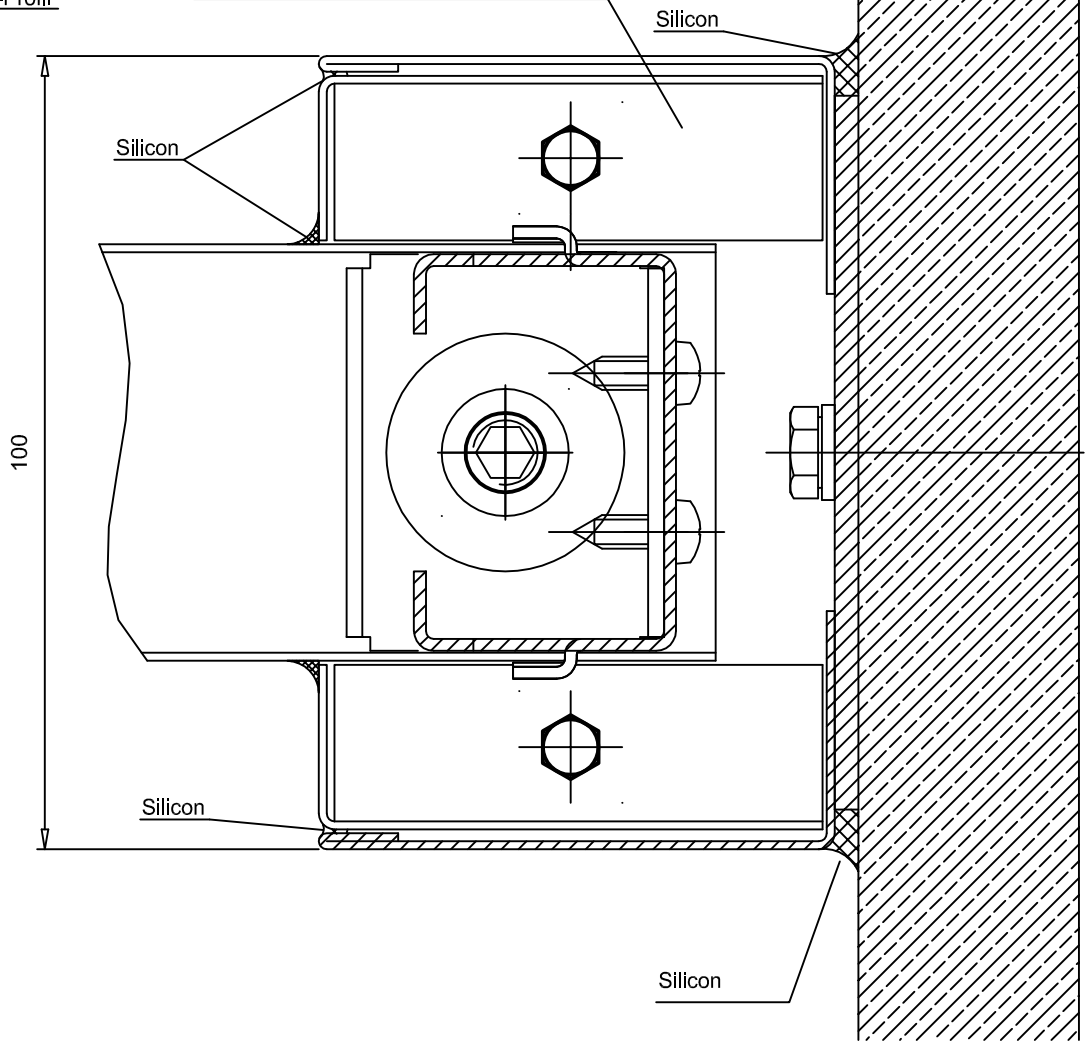
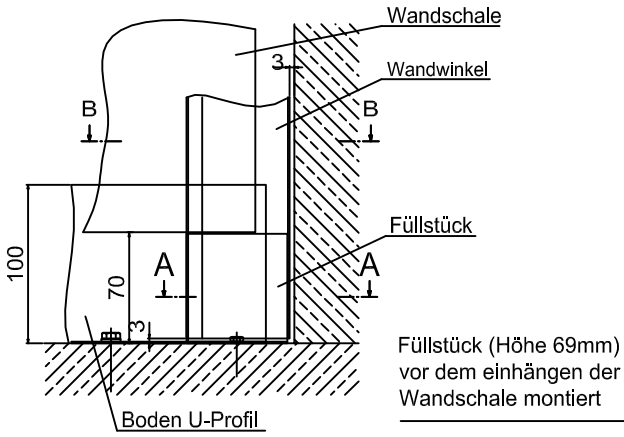

Alle Toleranzen nach DIN ISO 2768 mittel

This drawing is our literary property and may neither copied nor to be exposed approachable to third persons without our agreement; according to German Copyright Act

Material

OCTANORM 

Datum

Name

Description / Bezeichnung:

Gezeichnet

23.07.2014

jk

D 002 B Wandanschluss Trennwand voll

Kontrolliert

Norm

Projekt Nr.

PRO_XXX

Z-Nr: VRS_P90_12_0006

1

A4

Status Änderungen Datum Name

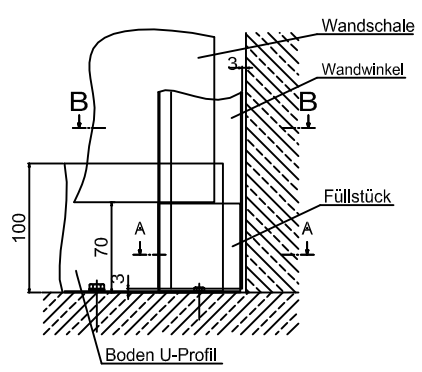

Schnitt B-B

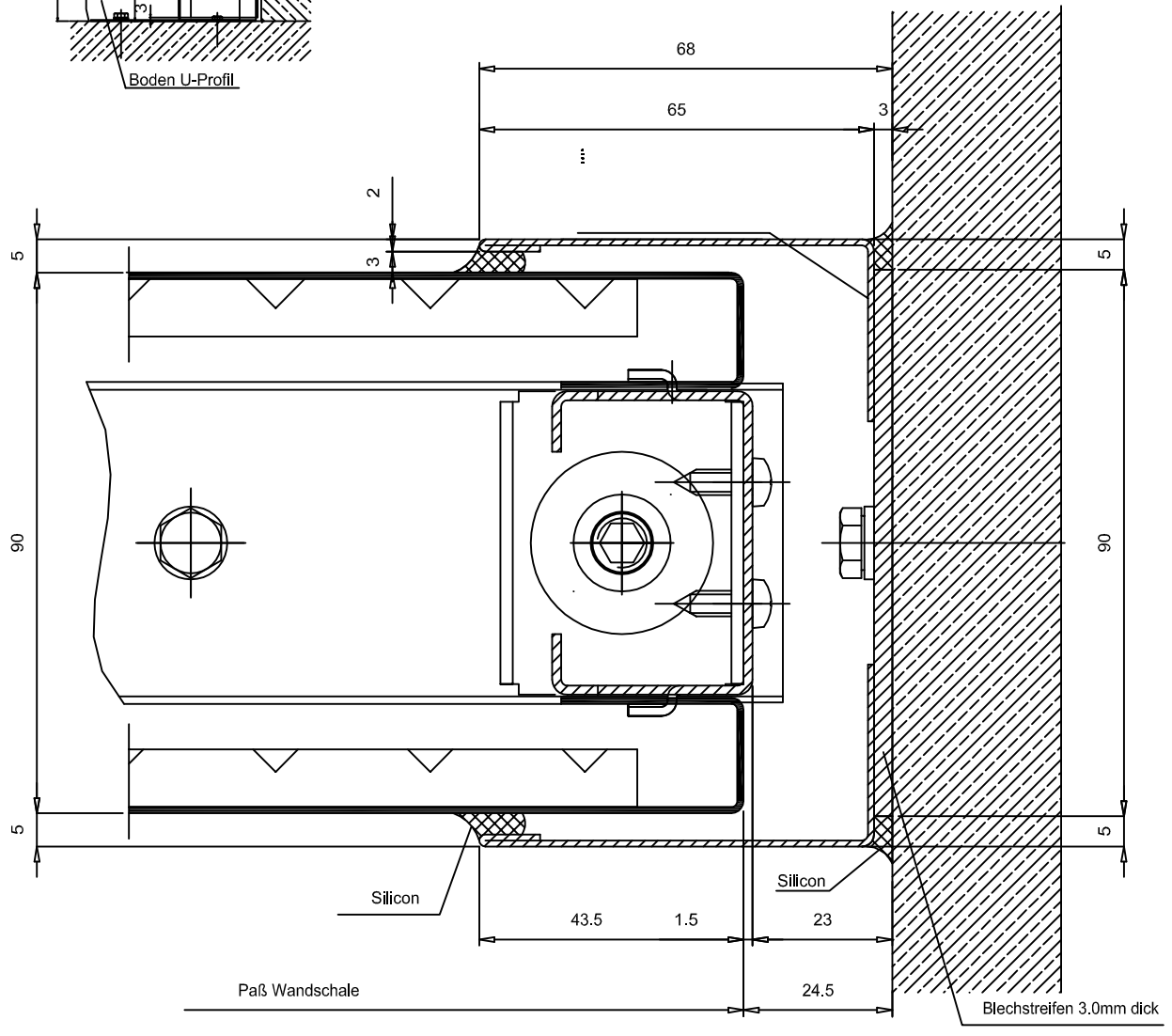

Alle Toleranzen nach DIN ISO 2768 mittel		Material		
<small>This drawing is our literary property and may neither copied nor to be exposed approachable to third persons without our agreement; according to German Copyright Act</small>				
		Datum	Name	Description / Bezeichnung: D 002 C Wandanschluss Trennwand voll
		Gezeichnet	23.07.2014 jk	
		Kontrolliert		
		Norm		
		Projekt Nr.		Z-Nr: VRS_P90_12_0007
		PRO_XXX		
Status	Änderungen	Datum	Name	<div style="text-align: right; font-size: 24pt; font-weight: bold;">1</div> <div style="text-align: right;">A4</div>

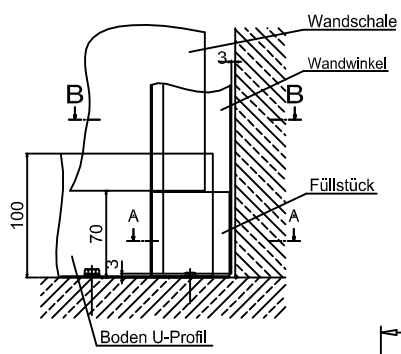

Schnitt B-B

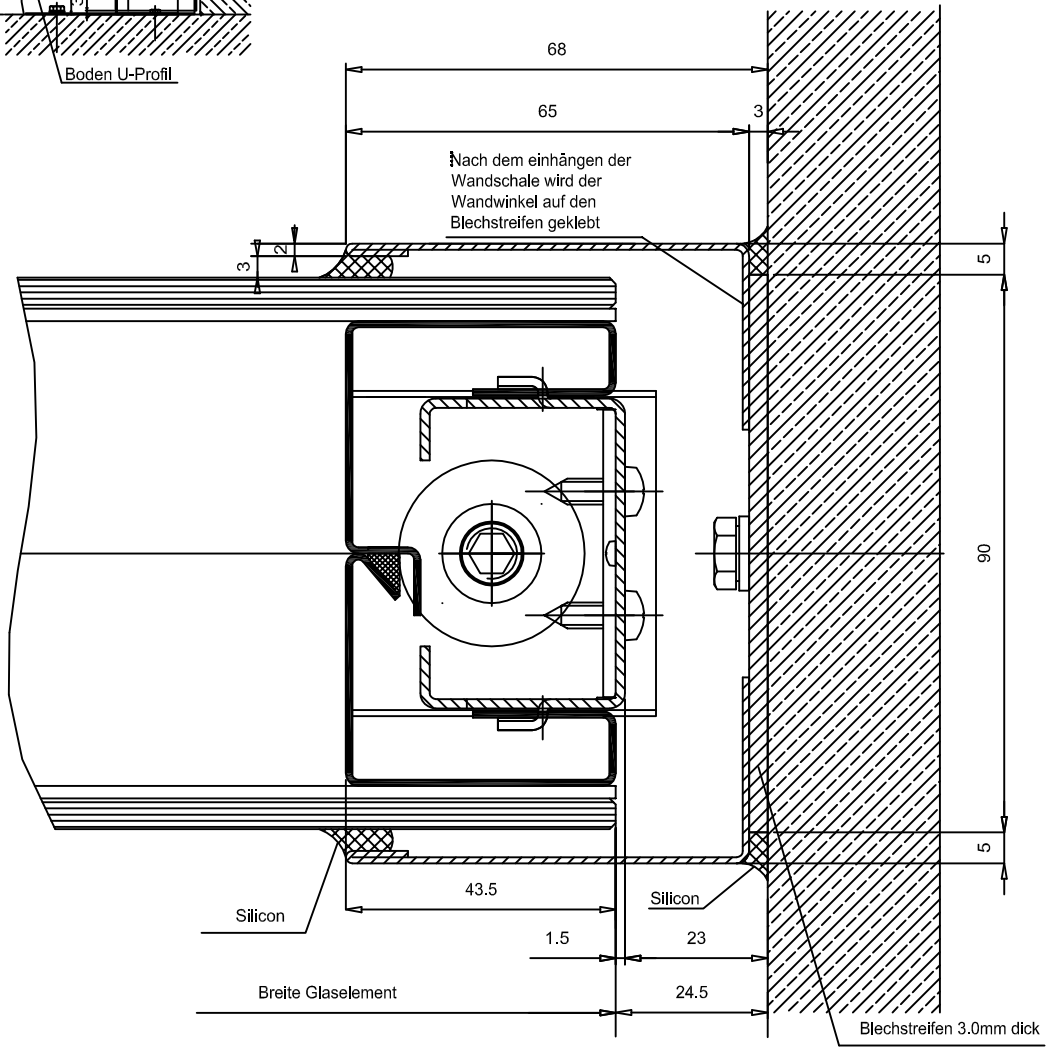

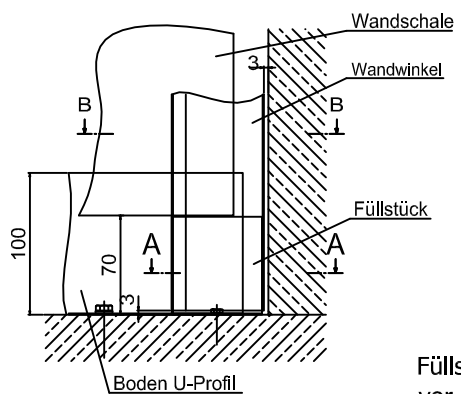

Alle Toleranzen nach DIN ISO 2768 mittel				Material			
This drawing is our literary property and may neither copied nor to be exposed approachable to third persons without our agreement; according to German Copyright Act							
			Datum	Name		Description / Bezeichnung: D 002 D Wandanschluss Glaselement	
			Gezeichnet	23.07.2014	jk		
			Kontrolliert				
			Norm				
			Projekt Nr. PRO_XXX			Z-Nr: VRS_P90_12_0008	1
Status	Änderungen	Datum	Name			A4	



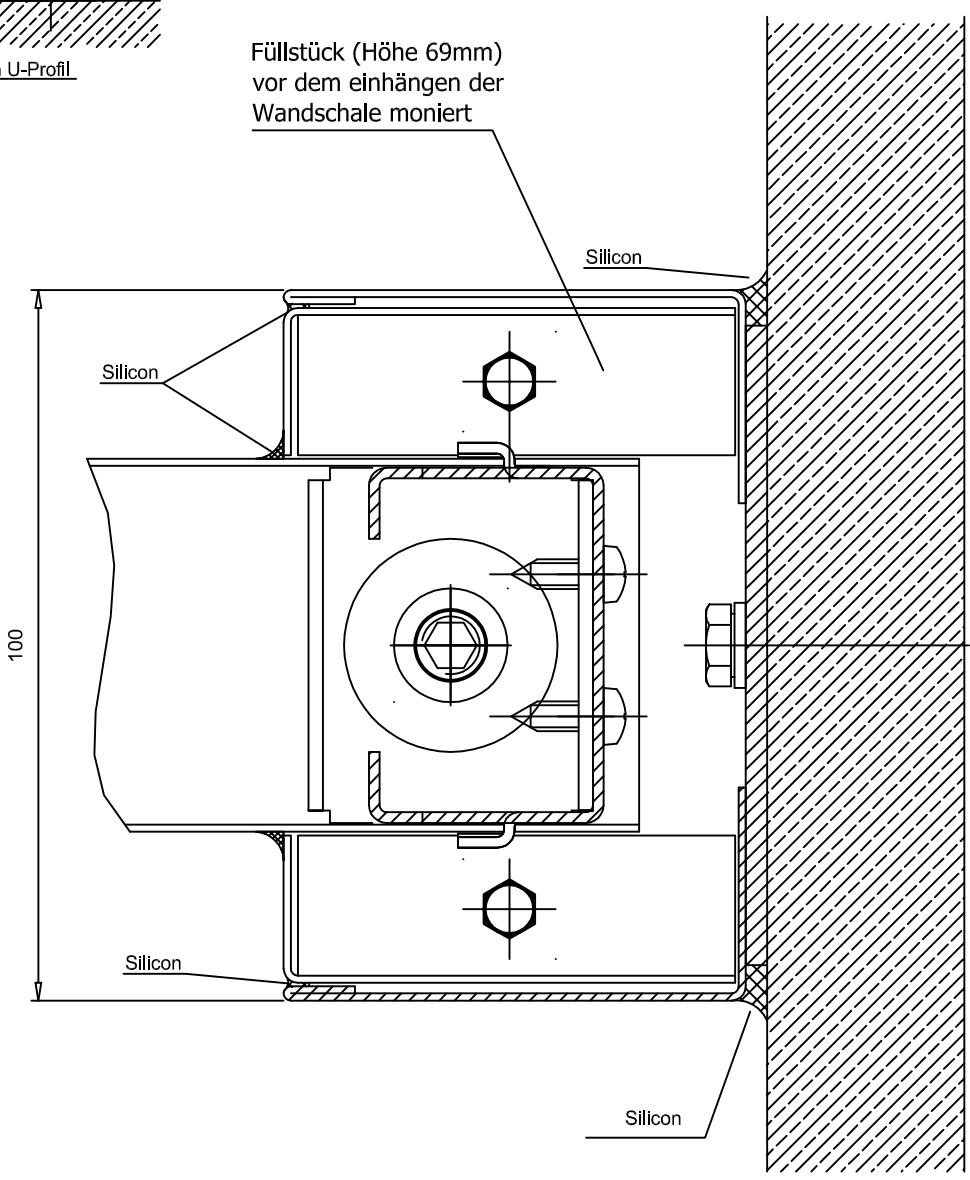

Schnitt A-A

Füllstück (Höhe 69mm)
vor dem einhängen der
Wandschale montiert

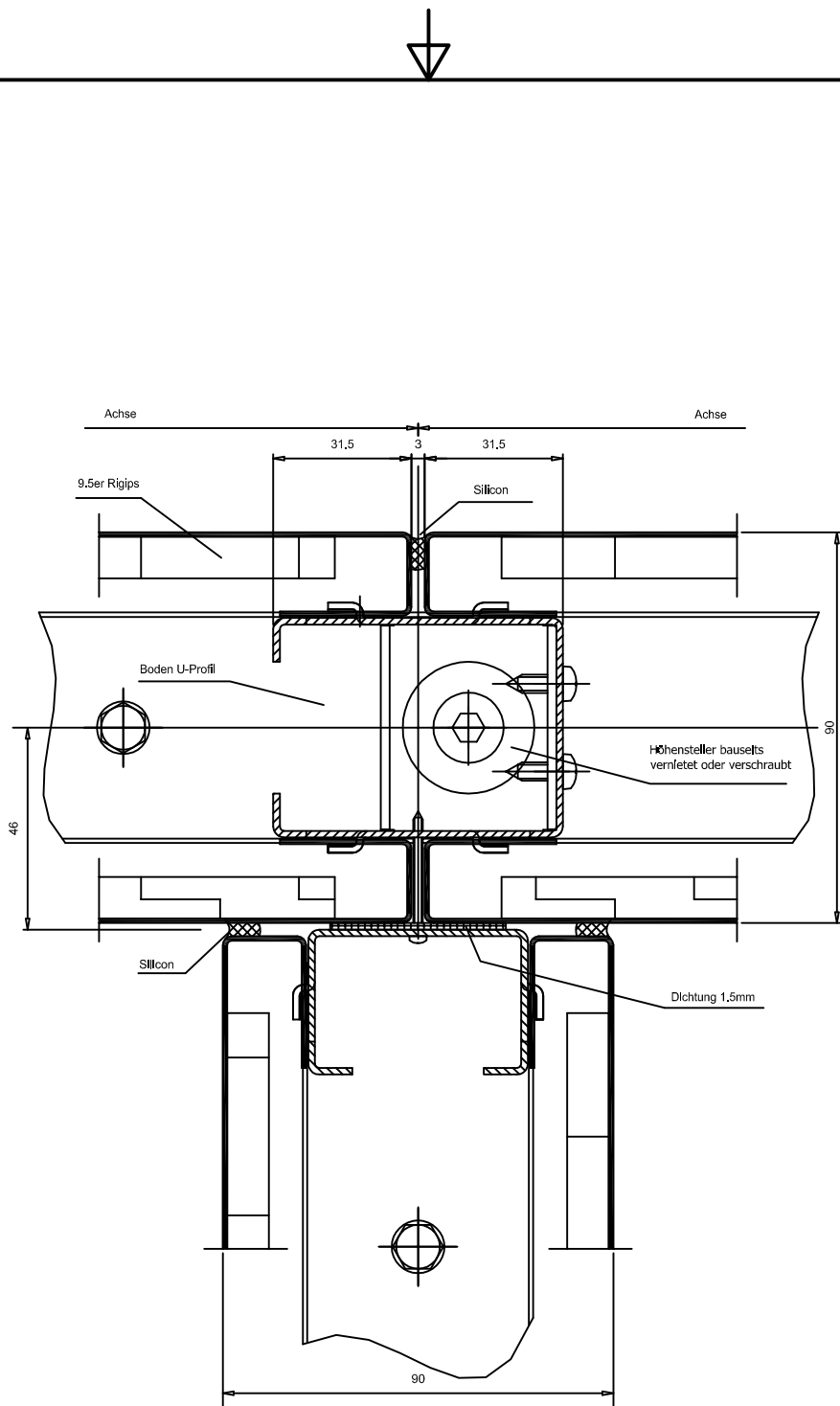

Alle Toleranzen nach DIN ISO 2768 mittel		Material		
<small>This drawing is our literary property and may neither copied nor to be exposed approachable to third persons without our agreement; according to German Copyright Act</small>				
		Datum	Name	Description / Bezeichnung: D 002 E Wandanschluss Glaselement
		Gezeichnet	23.07.2014 jk	
		Kontrolliert		
		Norm		
		Projekt Nr. PRO_XXX		Z-Nr: VRS_P90_12_0009
Status	Änderungen	Datum	Name	1 A4



Alle Toleranzen nach DIN ISO 2768 mittel			Material		
This drawing is our literary property and may neither copied nor to be exposed approachable to third persons without our agreement; according to German Copyright Act					
			Datum	Name	Description / Bezeichnung: D 003 T-Anschluss Voll/Voll/Voll
			Gezeichnet	23.07.2014 jk	
			Kontrolliert		
			Norm		
			Projekt Nr. PRO_XXX		Z-Nr: VRS_P90_12_0010
Status	Änderungen	Datum	Name		1 A4

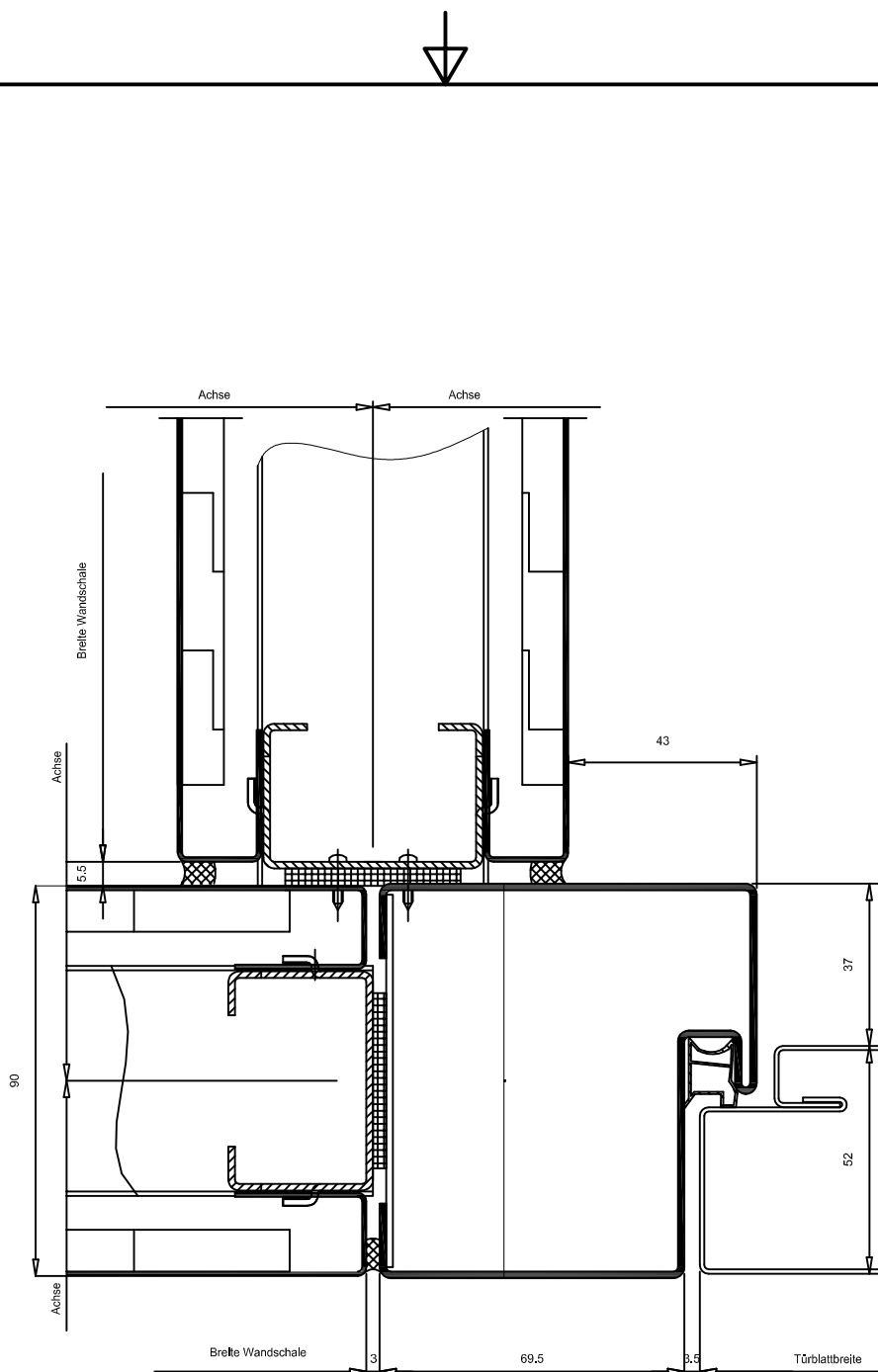

Alle Toleranzen nach DIN ISO 2768 mittel				Material		
This drawing is our literary property and may neither copied nor to be exposed approachable to third persons without our agreement; according to German Copyright Act						
				Datum	Name	Description / Bezeichnung: D 003 A T-Anschluss Trennwand Voll/Voll/Tür
				Gezeichnet	23.07.2014 jk	
				Kontrolliert		
				Norm		
				Projekt Nr. PRO_XXX		Z-Nr: VRS_P90_12_0011
						1
						A4
Status	Änderungen	Datum	Name			

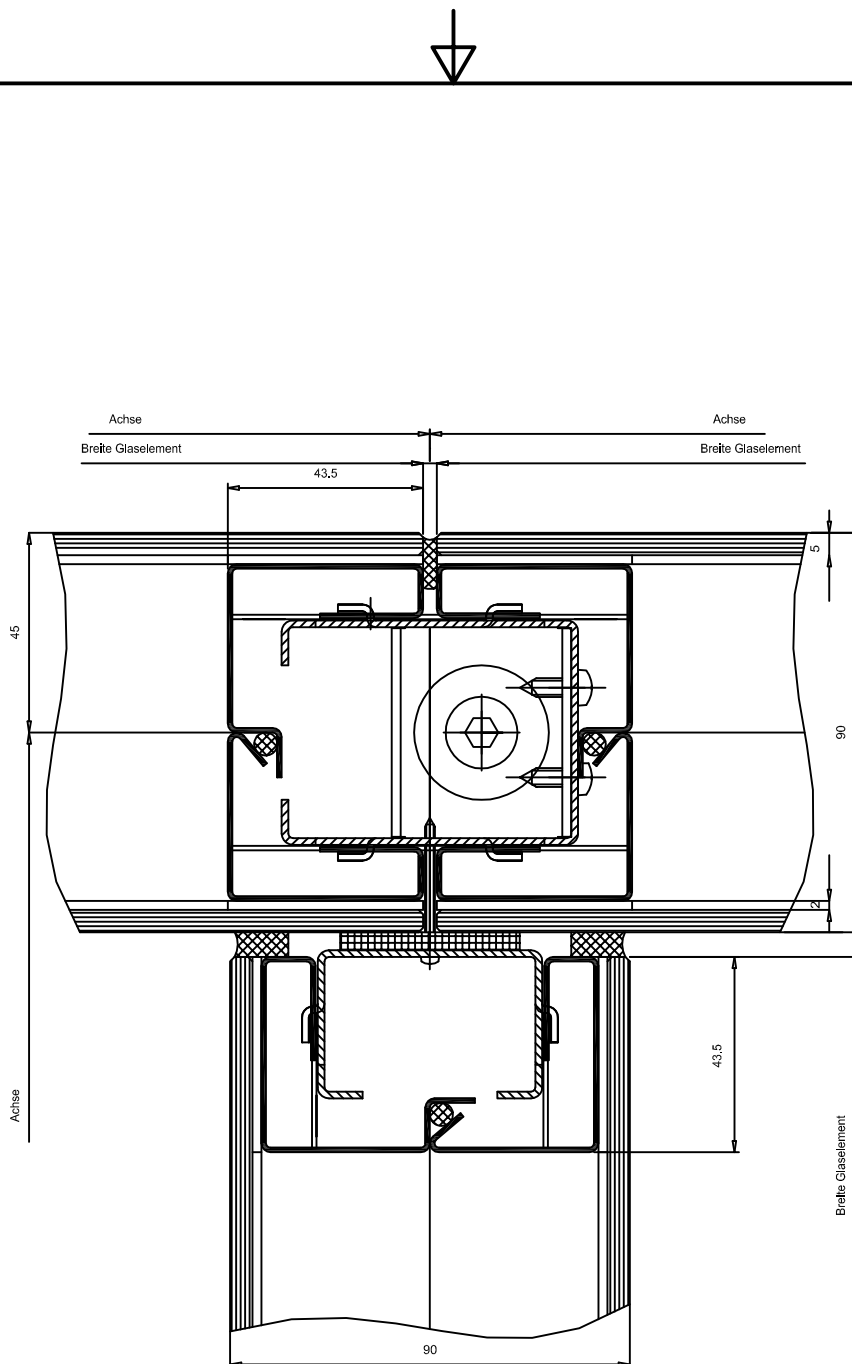

Alle Toleranzen nach DIN ISO 2768 mittel				Material		
This drawing is our literary property and may neither copied nor to be exposed approachable to third persons without our agreement; according to German Copyright Act						
				Datum	Name	Description / Bezeichnung: D 003 B T-Anschluss Trennwand Glas/Glas/Glas
				Gezeichnet	24.07.2014 jk	
				Kontrolliert		
				Norm		
				Projekt Nr. PRO_XXX		Z-Nr: VRS_P90_12_0012
						1
						A4
Status	Änderungen	Datum	Name			

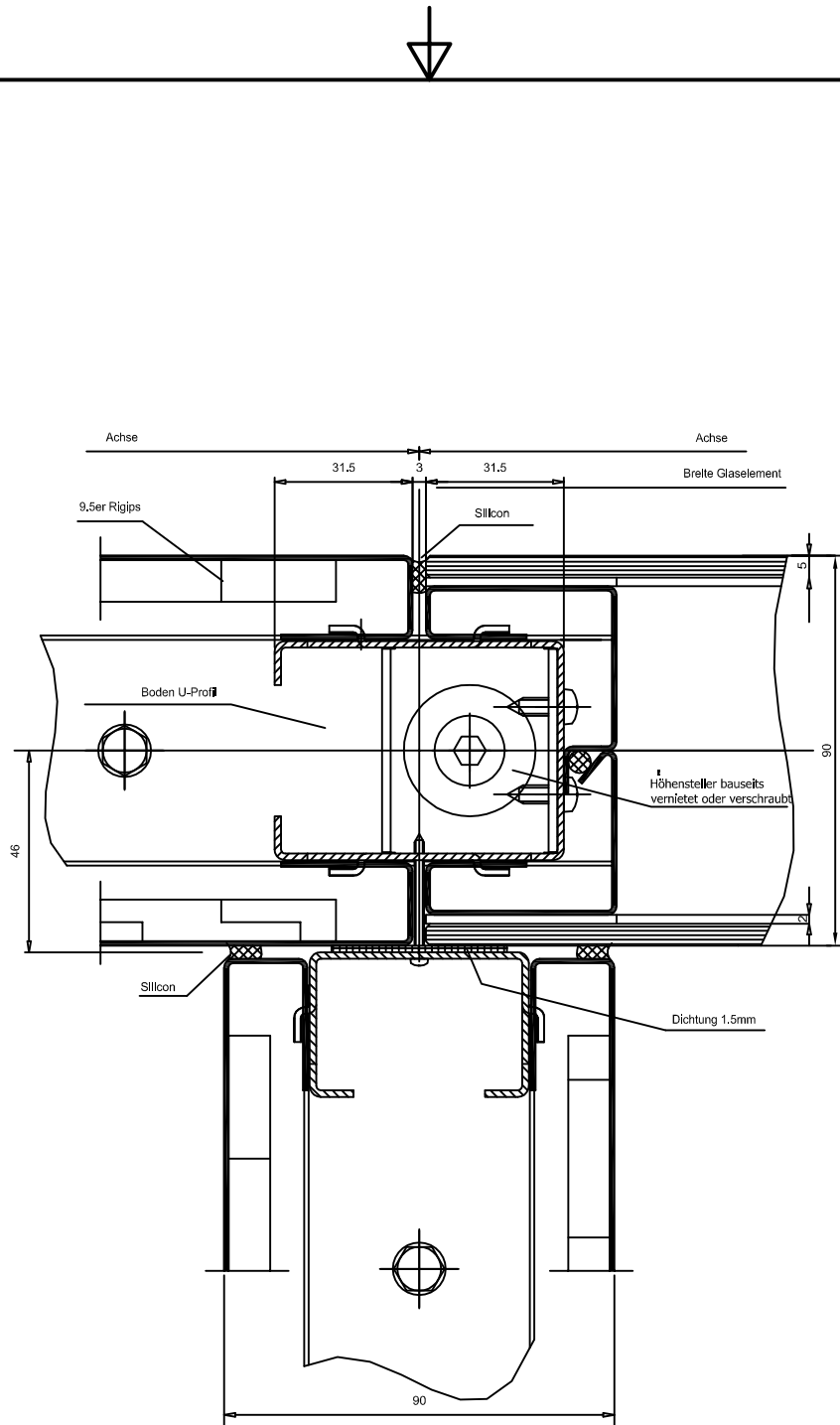

Alle Toleranzen nach DIN ISO 2768 mittel		Material		
<small>This drawing is our literary property and may neither copied nor to be exposed approachable to third persons without our agreement; according to German Copyright Act</small>				
		Datum	Name	Description / Bezeichnung: D 003 C T-Anschluss Trennwand Voll/Glas/Voll
		Gezeichnet	24.07.2014 jk	
		Kontrolliert		
		Norm		
		Projekt Nr.		Z-Nr: VRS_P90_12_0013
		PRO_XXX		
Status	Änderungen	Datum	Name	1 A4

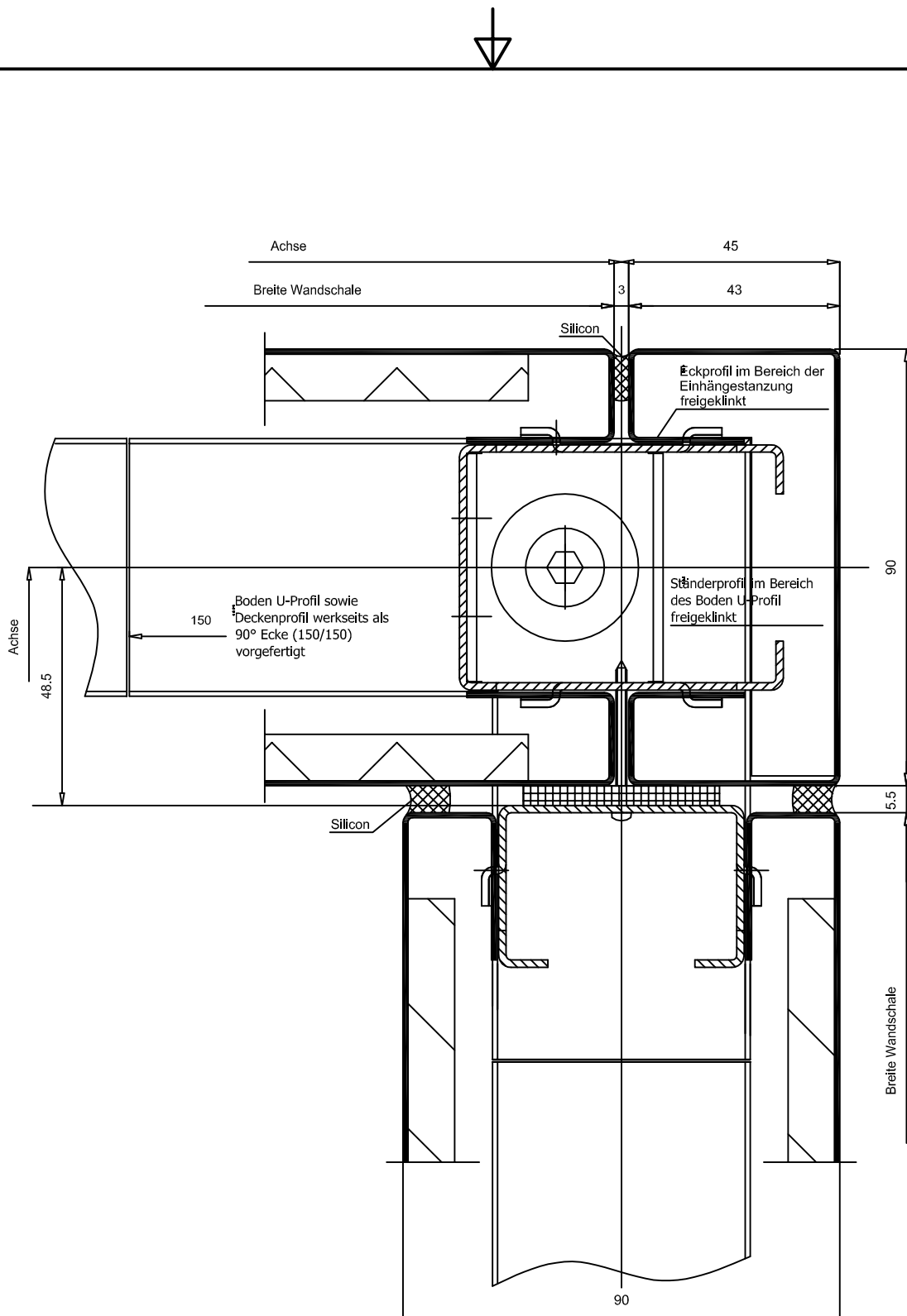

Alle Toleranzen nach DIN ISO 2768 mittel			Material			
This drawing is our literary property and may neither copied nor to be exposed approachable to third persons without our agreement; according to German Copyright Act						
			Datum	Name	Description / Bezeichnung: D 004 Eckausbildung Trennwand Voll/Voll	
			Gezeichnet	24.07.2014		jk
			Kontrolliert			
			Norm			
			Projekt Nr. PRO_XXX		Z-Nr: VRS_P90_12_0014	1
						A4
Status	Änderungen	Datum	Name			

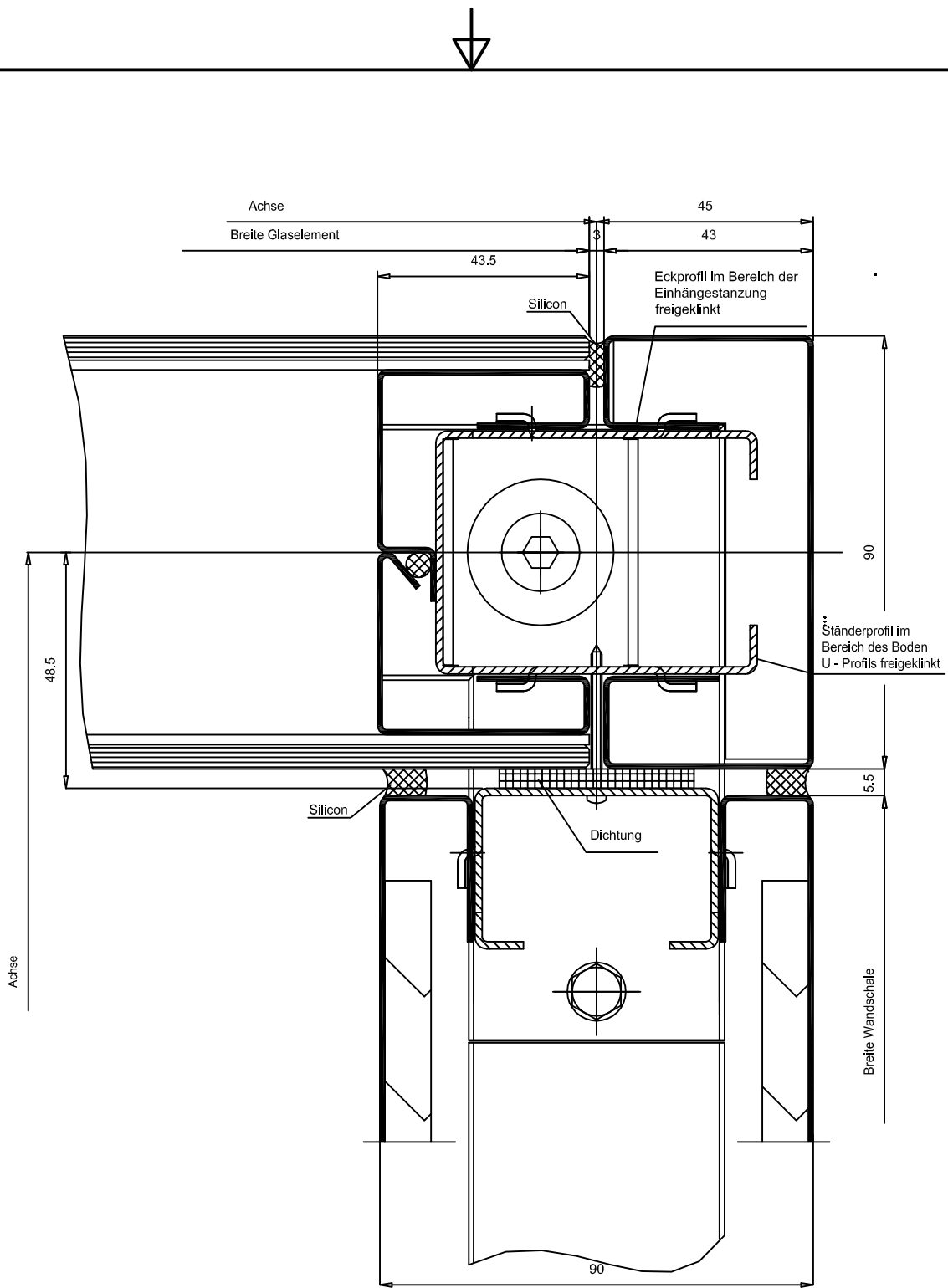

Alle Toleranzen nach DIN ISO 2768 mittel		Material		
This drawing is our literary property and may neither copied nor to be exposed approachable to third persons without our agreement; according to German Copyright Act				
		Datum	Name	Description / Bezeichnung: D 004 A Eckausbildung Trennwand Voll/Verglast
		Gezeichnet	24.07.2014 jk	
		Kontrolliert		
		Norm		
		Projekt Nr. PRO_XXX		Z-Nr: VRS_P90_12_0015
Status	Änderungen	Datum	Name	1 A4

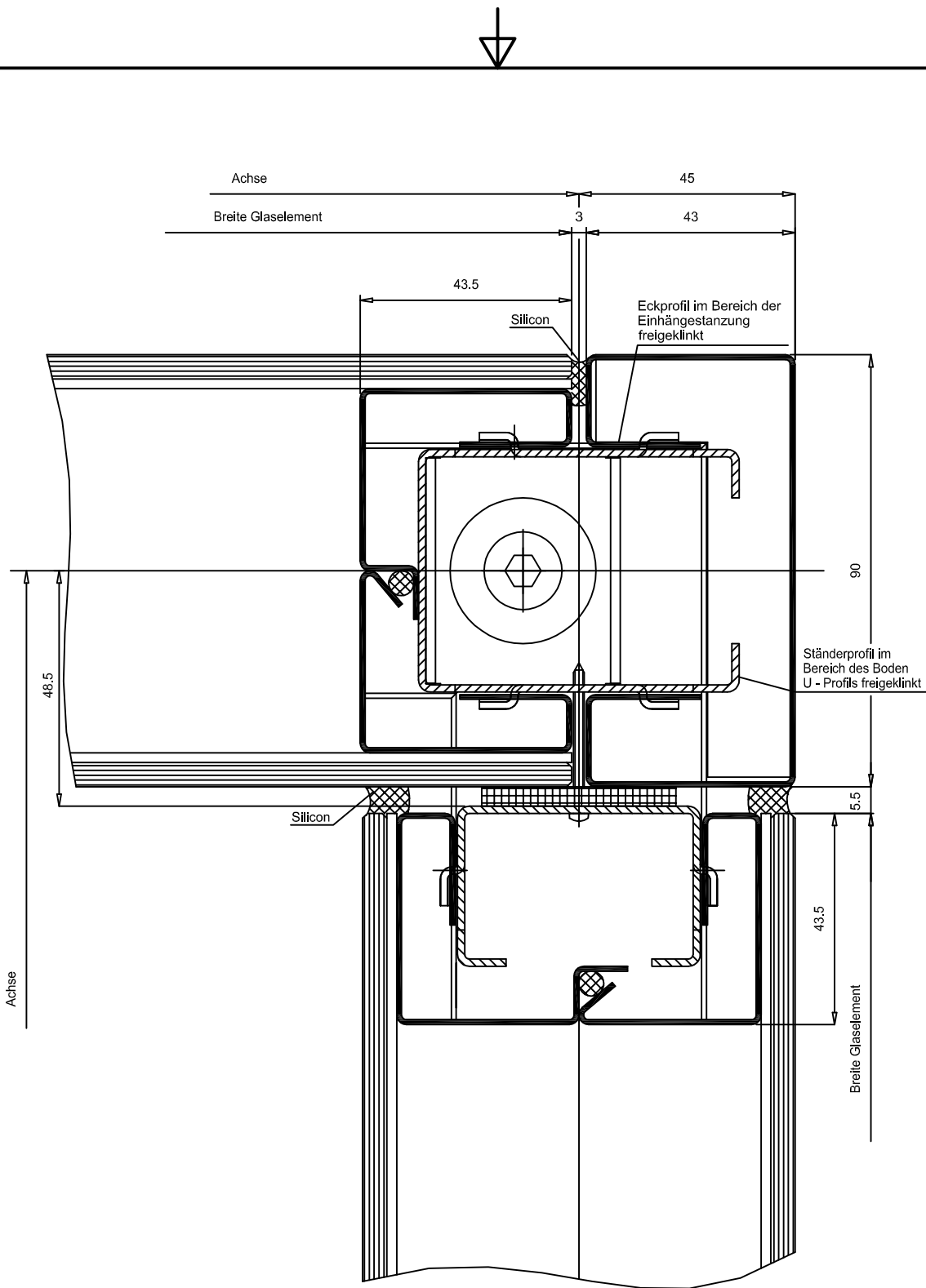

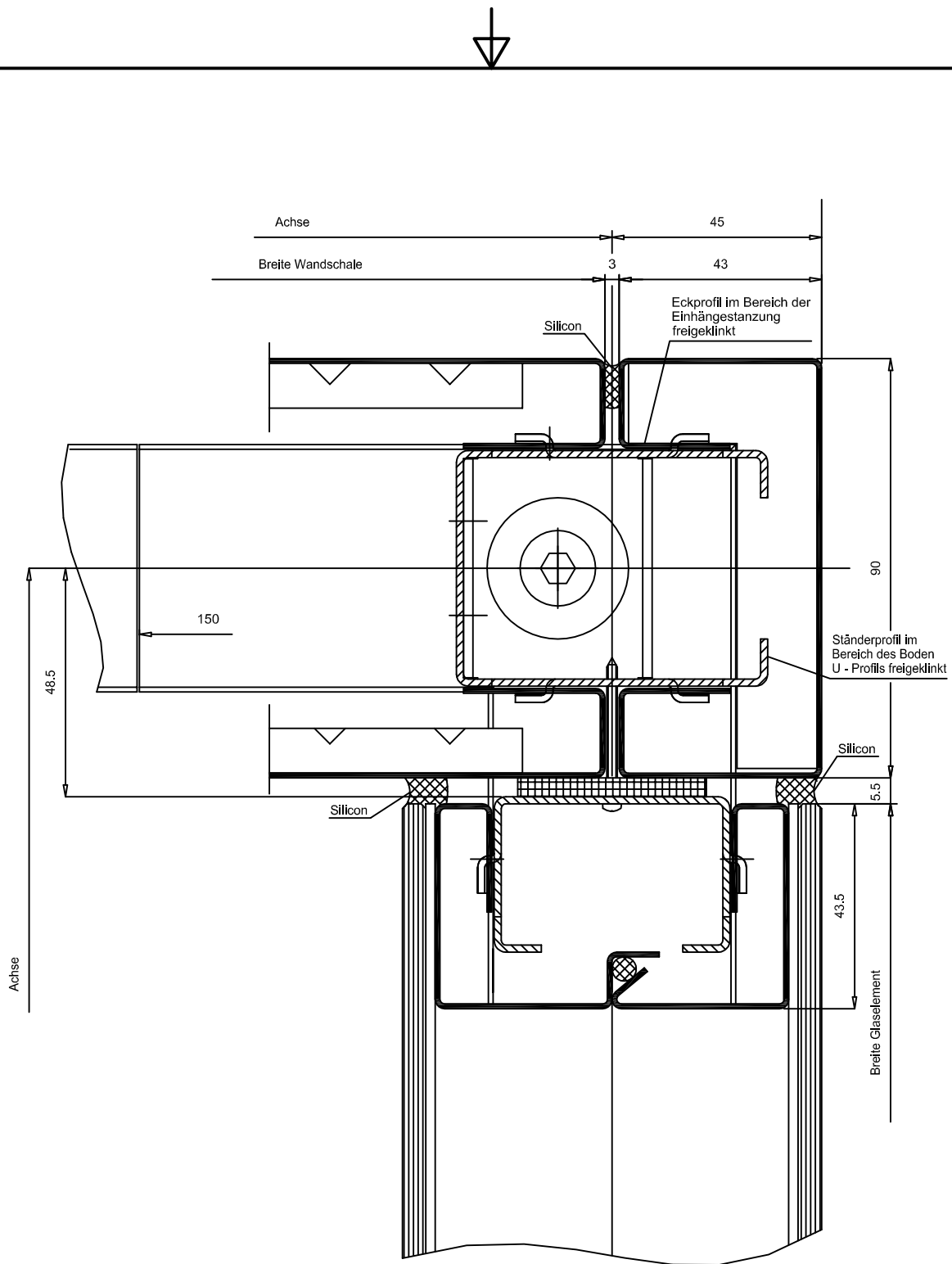

Alle Toleranzen nach DIN ISO 2768 mittel This drawing is our literary property and may neither copied nor to be exposed approachable to third persons without our agreement; according to German Copyright Act			Material			
			Datum 24.07.2014	Name jk		Description / Bezeichnung: D 004 B Eckausbildung Trennwand Verglast/Verglast
			Gezeichnet			
			Kontrolliert			
			Norm			
			Projekt Nr. PRO_XXX		Z-Nr: VRS_P90_12_0016	
						1 A4
Status	Änderungen	Datum	Name			

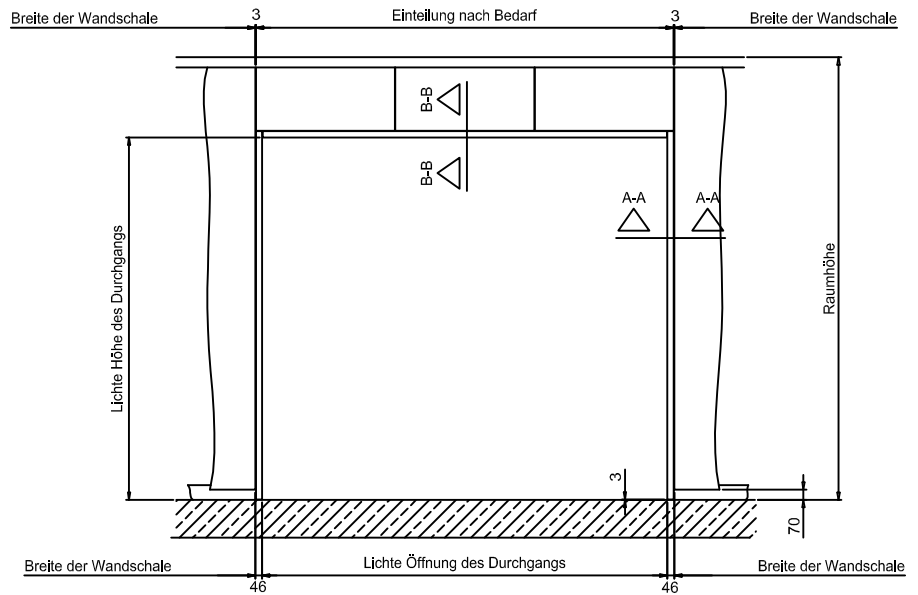
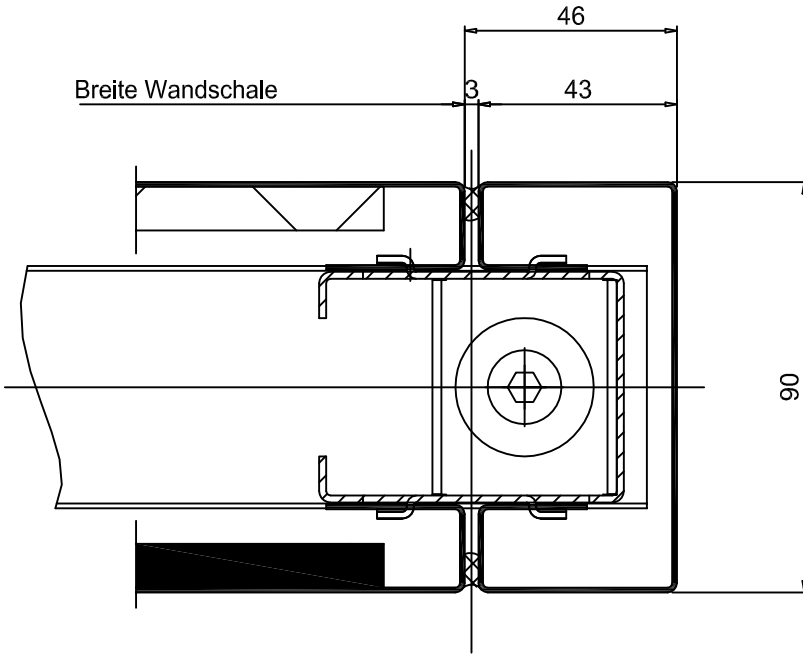

Alle Toleranzen nach DIN ISO 2768 mittel		Material		
This drawing is our literary property and may neither copied nor to be exposed approachable to third persons without our agreement; according to German Copyright Act				
		Datum	Name	Description / Bezeichnung: D 004 C Eckausbildung Trennwand Verglast/Voll
		Gezeichnet	24.07.2014 jk	
		Kontrolliert		
		Norm		
		Projekt Nr. PRO_XXX		Z-Nr: VRS_P90_12_0017
Status	Änderungen	Datum	Name	1 A4

Schnitt A-A



Alle Toleranzen nach DIN ISO 2768 mittel				Material			
This drawing is our literary property and may neither copied nor to be exposed approachable to third persons without our agreement; according to German Copyright Act							
				Datum	Name	Description / Bezeichnung: D 010 Durchgangszarge	
				Gezeichnet	25.07.2014		jk
				Kontrolliert			
				Norm			
				Projekt Nr. PRO_XXX		Z-Nr: VRS_P90_12_0018	
Status	Änderungen	Datum	Name			1 A4	



Schnitt A-A

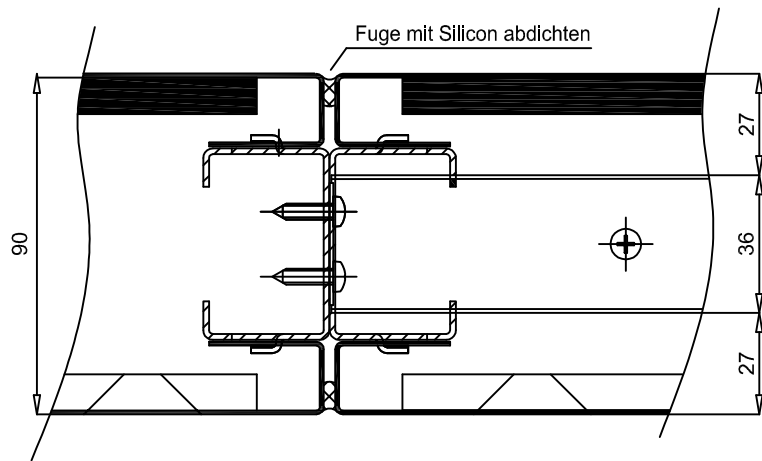

Schnitt B-B

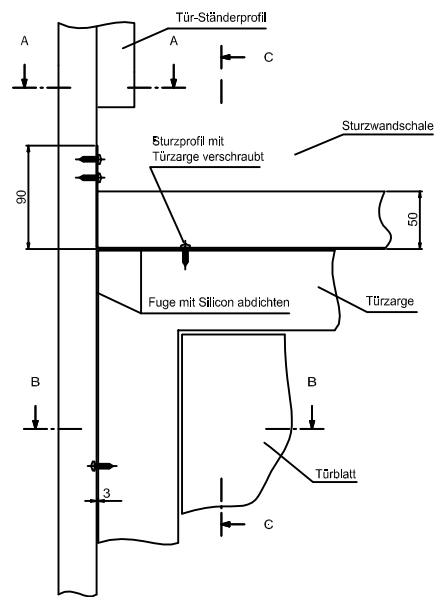
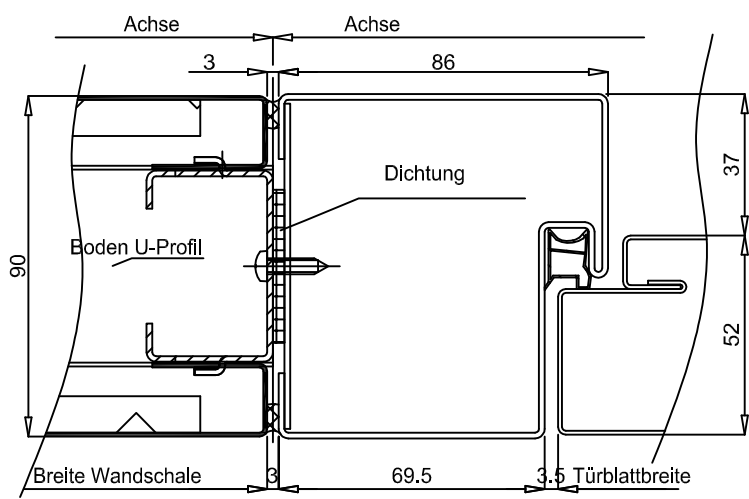

Alle Toleranzen nach DIN ISO 2768 mittel				Material			
This drawing is our literary property and may neither copied nor to be exposed approachable to third persons without our agreement; according to German Copyright Act							
				Datum	Name	Description / Bezeichnung: D 012 Türanschluss an Vollwand	
			Gezeichnet	25.07.2014	jk		
			Kontrolliert				
			Norm				
			Projekt Nr. PRO_XXX			Z-Nr: VRS_P90_12_0019	1
Status	Änderungen	Datum	Name			A4	

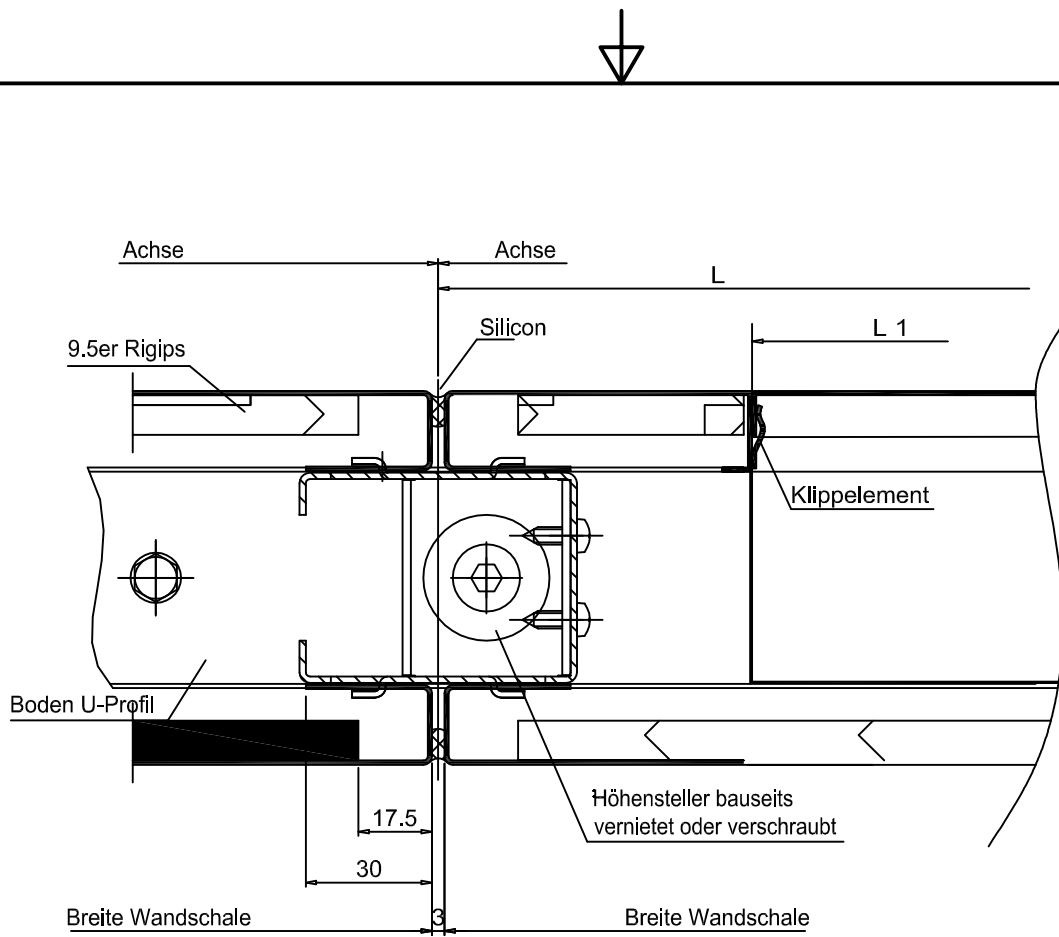

Ansicht

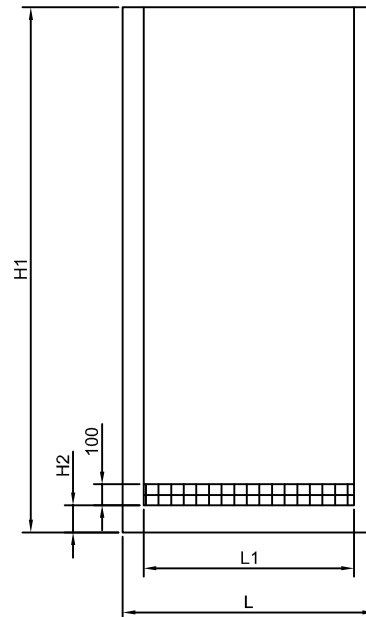

Alle Toleranzen nach DIN ISO 2768 mittel		Material		
This drawing is our literary property and may neither copied nor to be exposed approachable to third persons without our agreement; according to German Copyright Act				
		Datum	Name	Description / Bezeichnung: D 013 Rücklaufschacht integriert
		Gezeichnet	25.07.2014 jk	
		Kontrolliert		
		Norm		
		Projekt Nr. PRO_XXX		Z-Nr: VRS_P90_12_0020
				1
				A4
Status	Änderungen	Datum	Name	

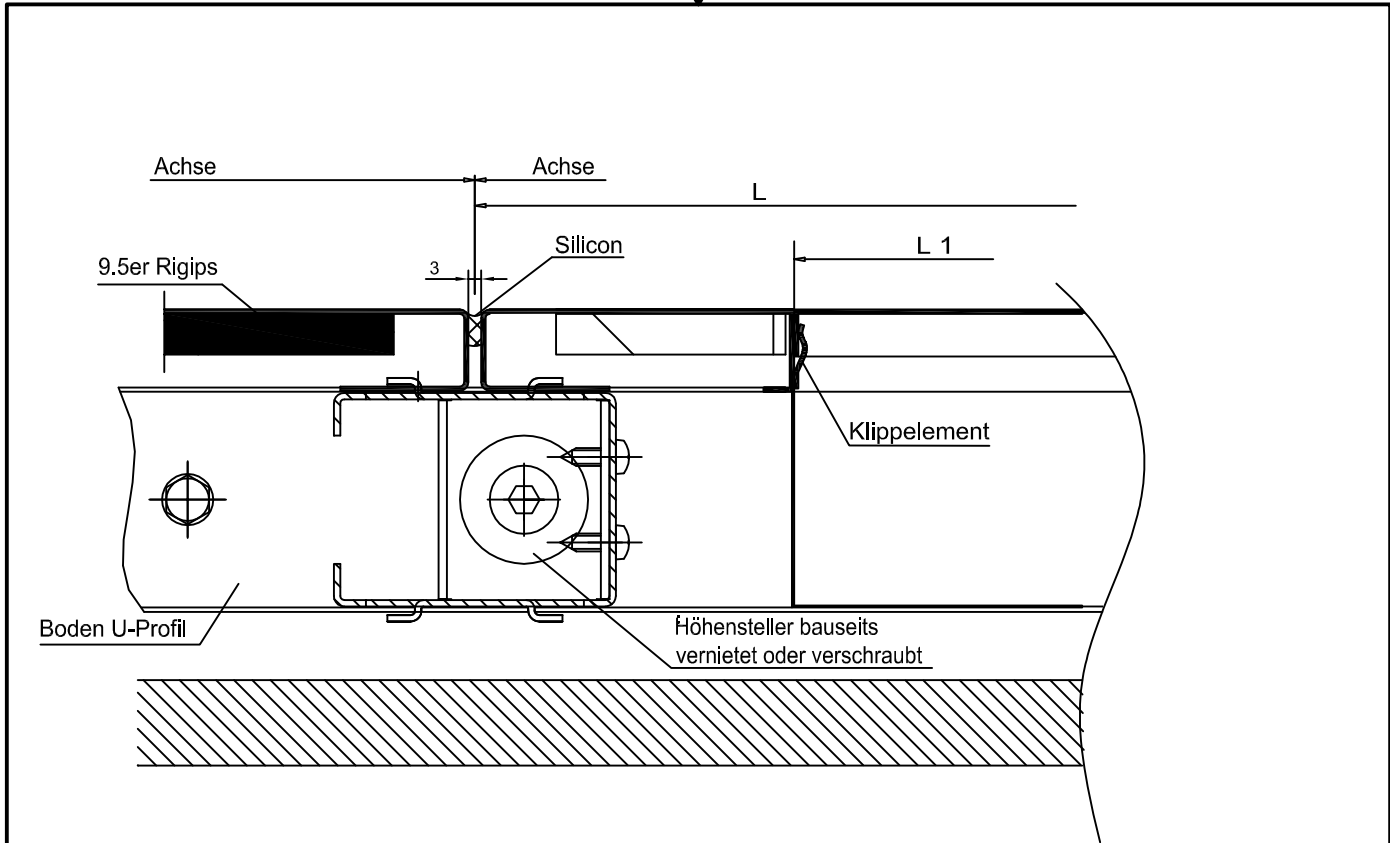

Ansicht

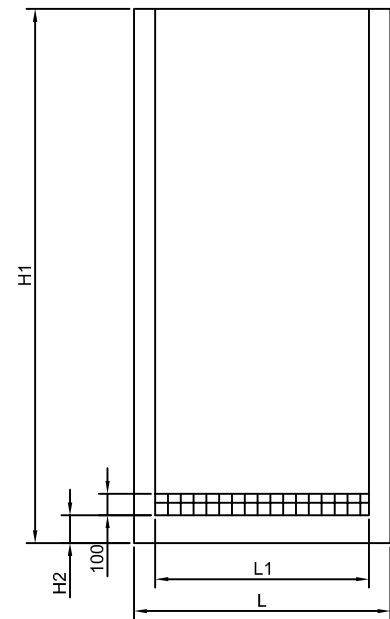

Alle Toleranzen nach DIN ISO 2768 mittel			Material		
This drawing is our literary property and may neither copied nor to be exposed approachable to third persons without our agreement; according to German Copyright Act					
			Datum	Name	Description / Bezeichnung: D 013 A Rückluftschaft integriert mit Wandverkleidung
			Gezeichnet	25.07.2014 jk	
			Kontrolliert		
			Norm		
			Projekt Nr. PRO_XXX		Z-Nr: VRS_P90_12_0021
Status	Änderungen	Datum	Name		1 A4

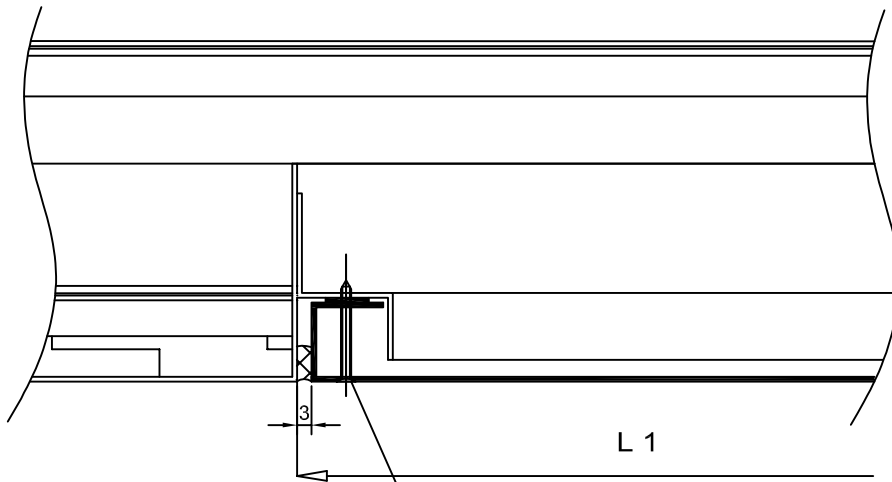

4 Befestigungsschrauben

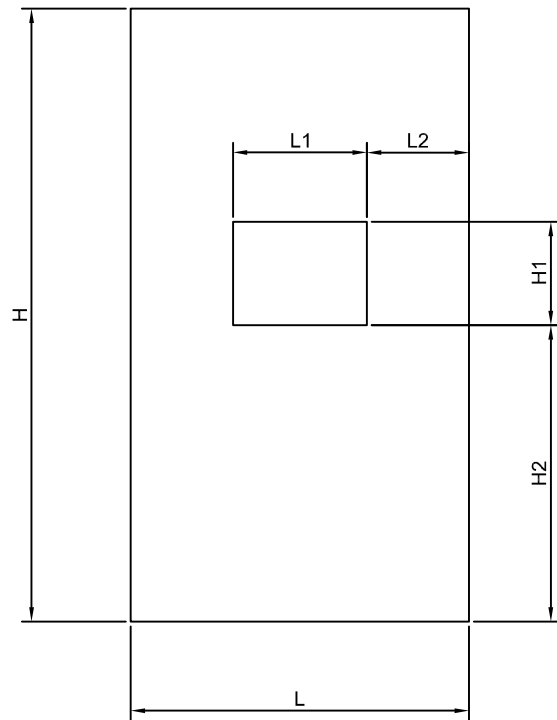

Alle Toleranzen nach DIN ISO 2768 mittel				Material		
This drawing is our literary property and may neither copied nor to be exposed approachable to third persons without our agreement; according to German Copyright Act						
				Datum	Name	Description / Bezeichnung: D 013 B Installation Trennwand halb
				Gezeichnet	25.07.2014 jk	
				Kontrolliert		
				Norm		
				Projekt Nr. PRO_XXX		Z-Nr: VRS_P90_12_0022
						1
						A4
Status	Änderungen	Datum	Name			

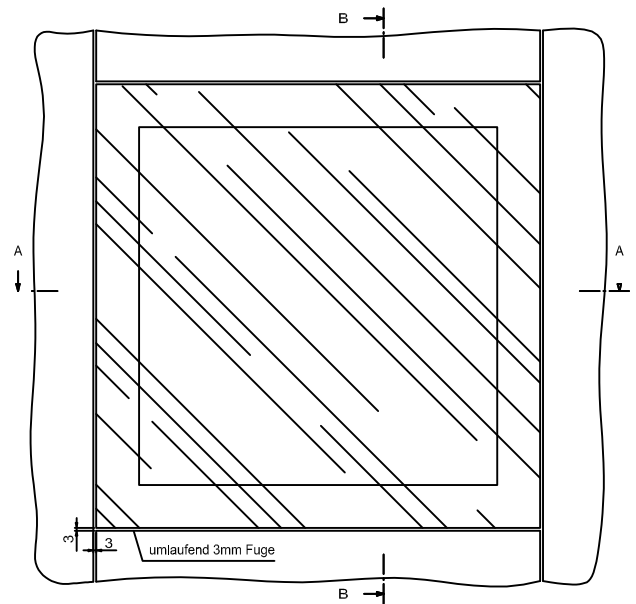

Schnitt A-A

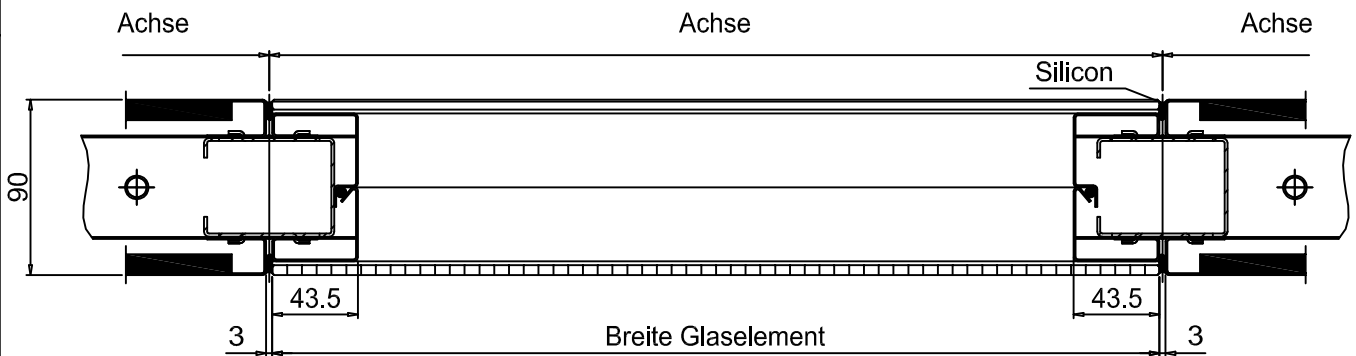

Alle Toleranzen nach DIN ISO 2768 mittel				Material		
This drawing is our literary property and may neither copied nor to be exposed approachable to third persons without our agreement; according to German Copyright Act						
				Datum	Name	Description / Bezeichnung: D 014 A Trennwandverglasung
				Gezeichnet	25.07.2014 jk	
				Kontrolliert		
				Norm		
				Projekt Nr. PRO_XXX		Z-Nr: VRS_P90_12_0023
						1
						A4
Status	Änderungen	Datum	Name			



TECHNISCHES DATENBLATT

WANDTYP P98

Wandsysteme mit vorgehängten Wandschalen

Oberfläche
Stützen / Profile

Aluminium natur

Oberfläche
Paneele

Pulverbeschichtet, Glanzgrad 30,
Rückseite grundiert 5 µm

Paneele

Stahlblechschalen 1 mm

Standardraster

1200 mm

Standardfarbe

RAL 9010

Füllung

keine oder nur auf Anfrage

Wandhöhe

2500 mm bis 4500 mm je nach
vorliegendem Raster

Wandstärke

98 mm

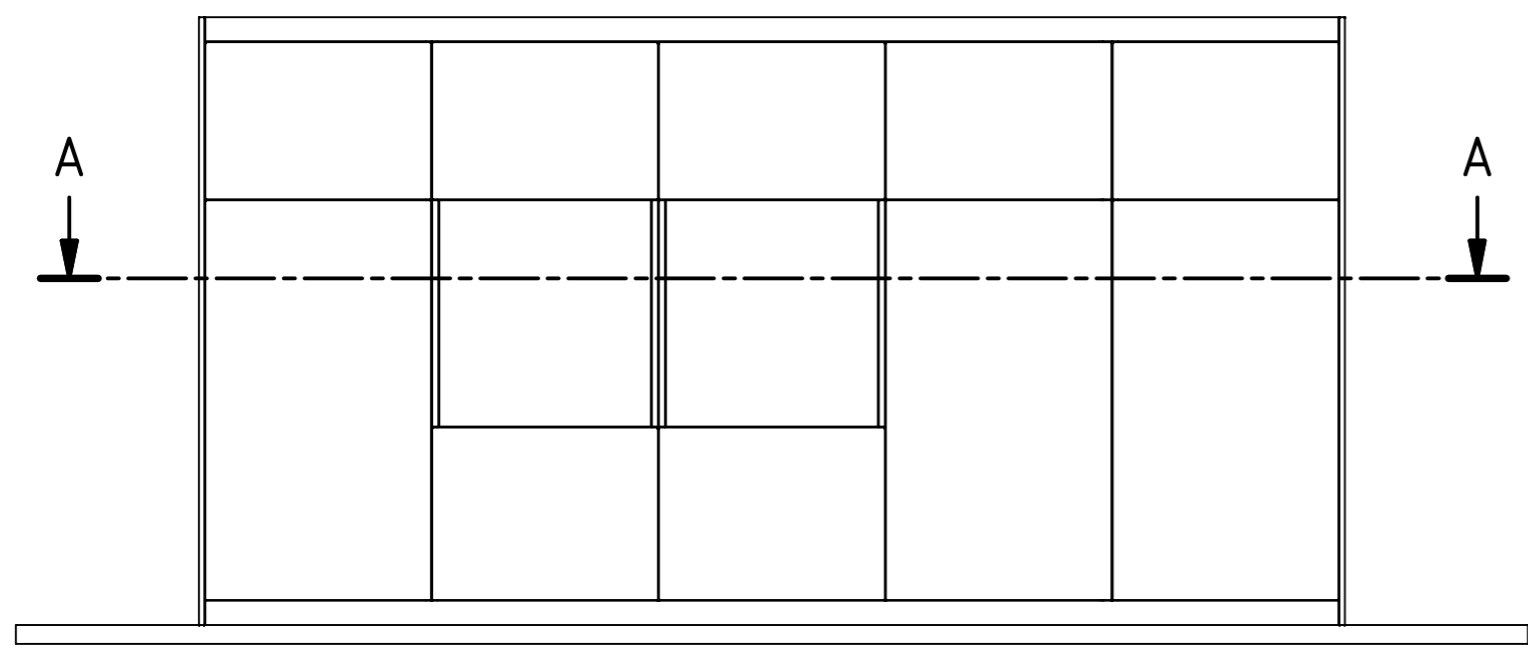

A-A

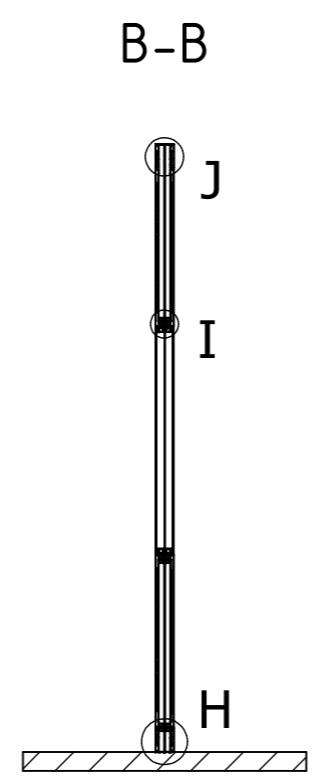

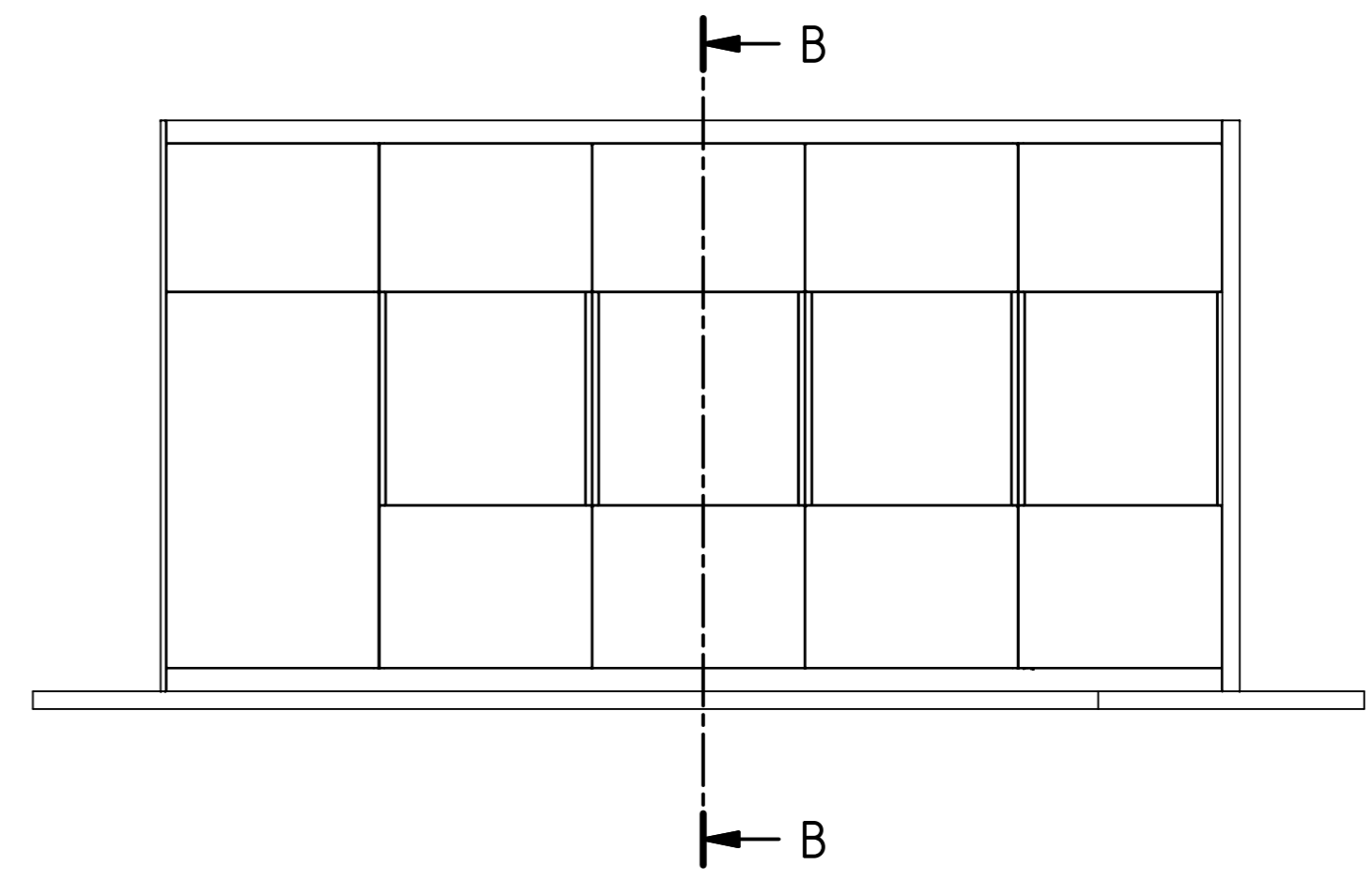

B-B



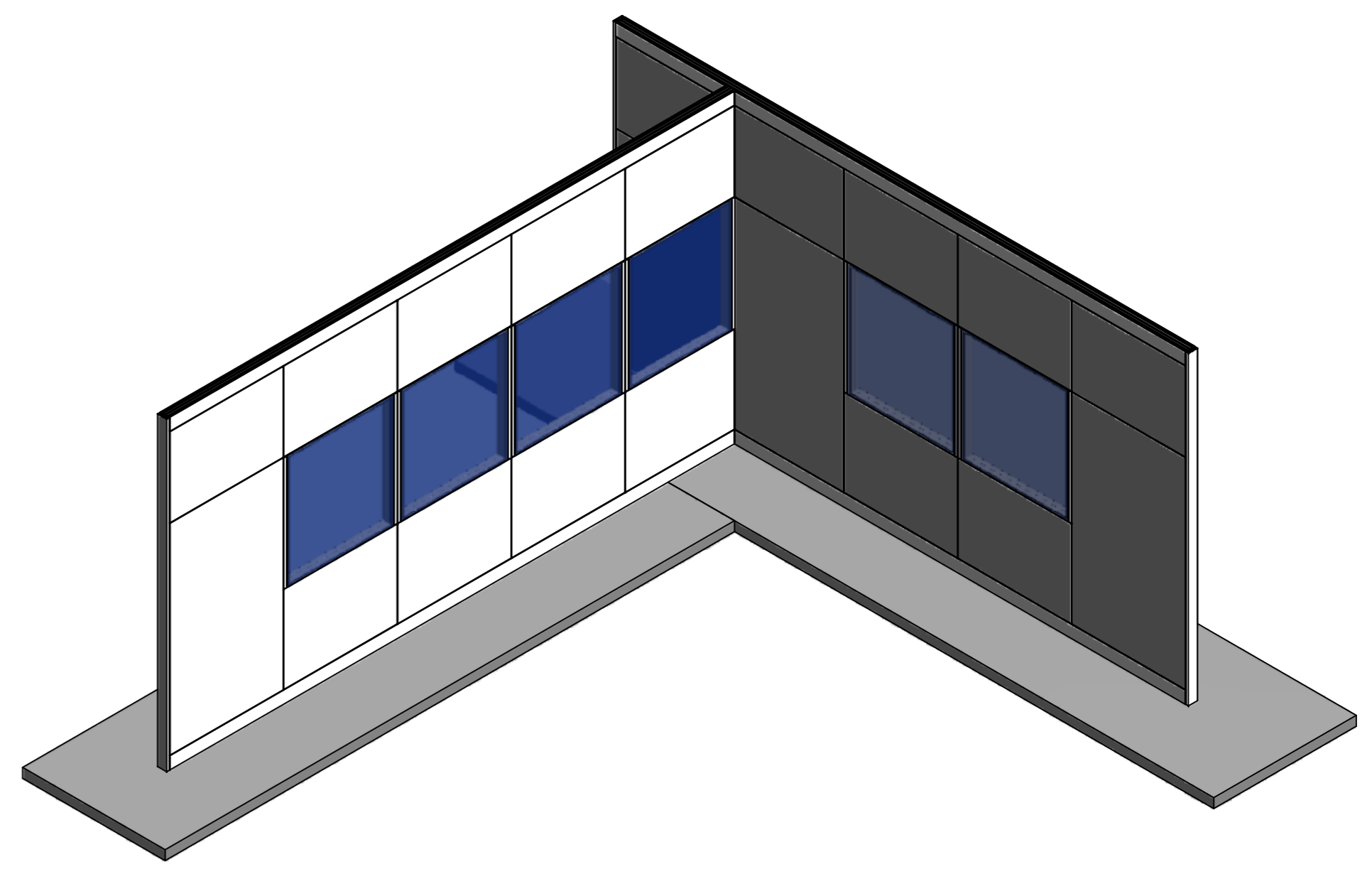
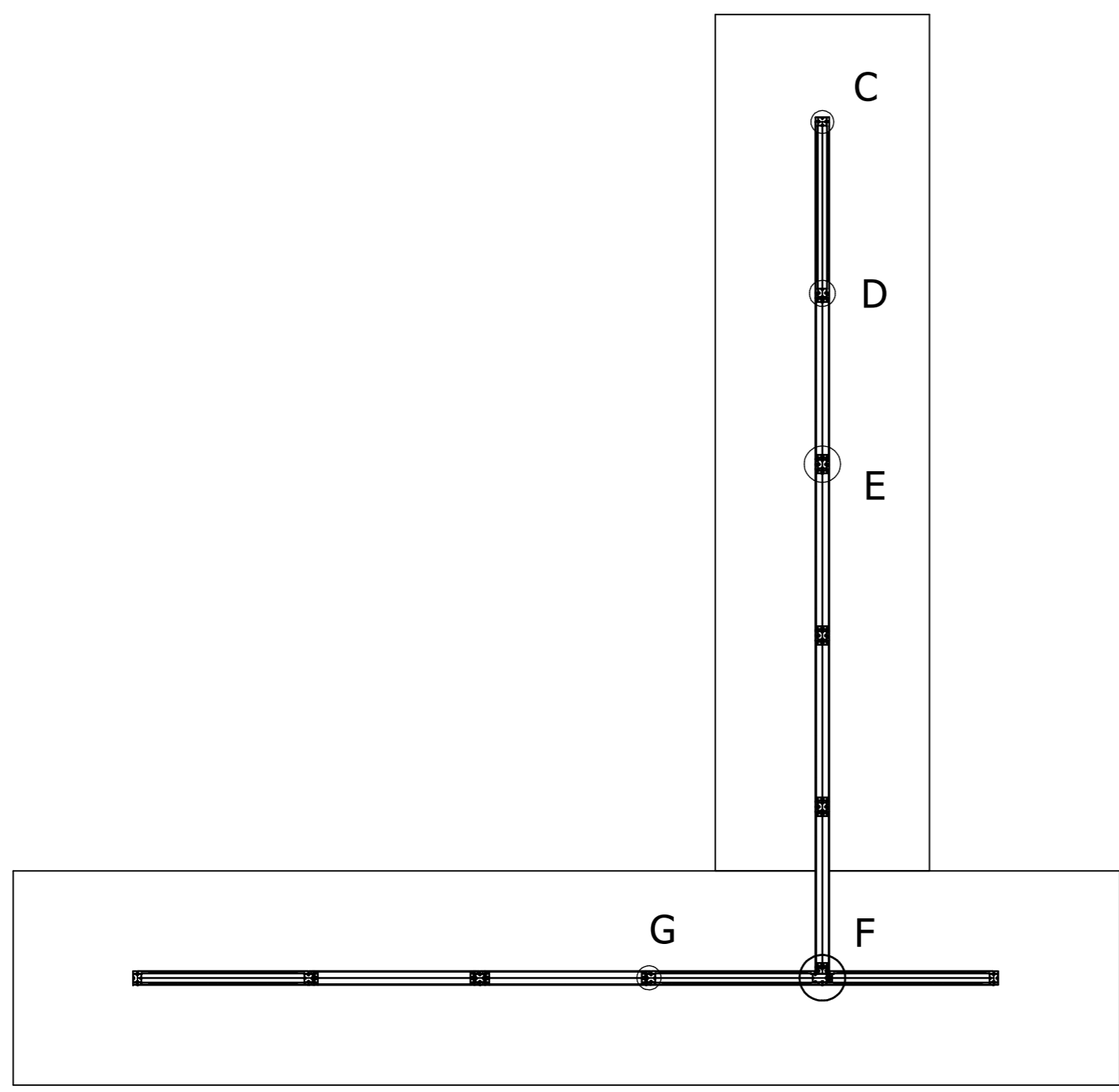

B

B

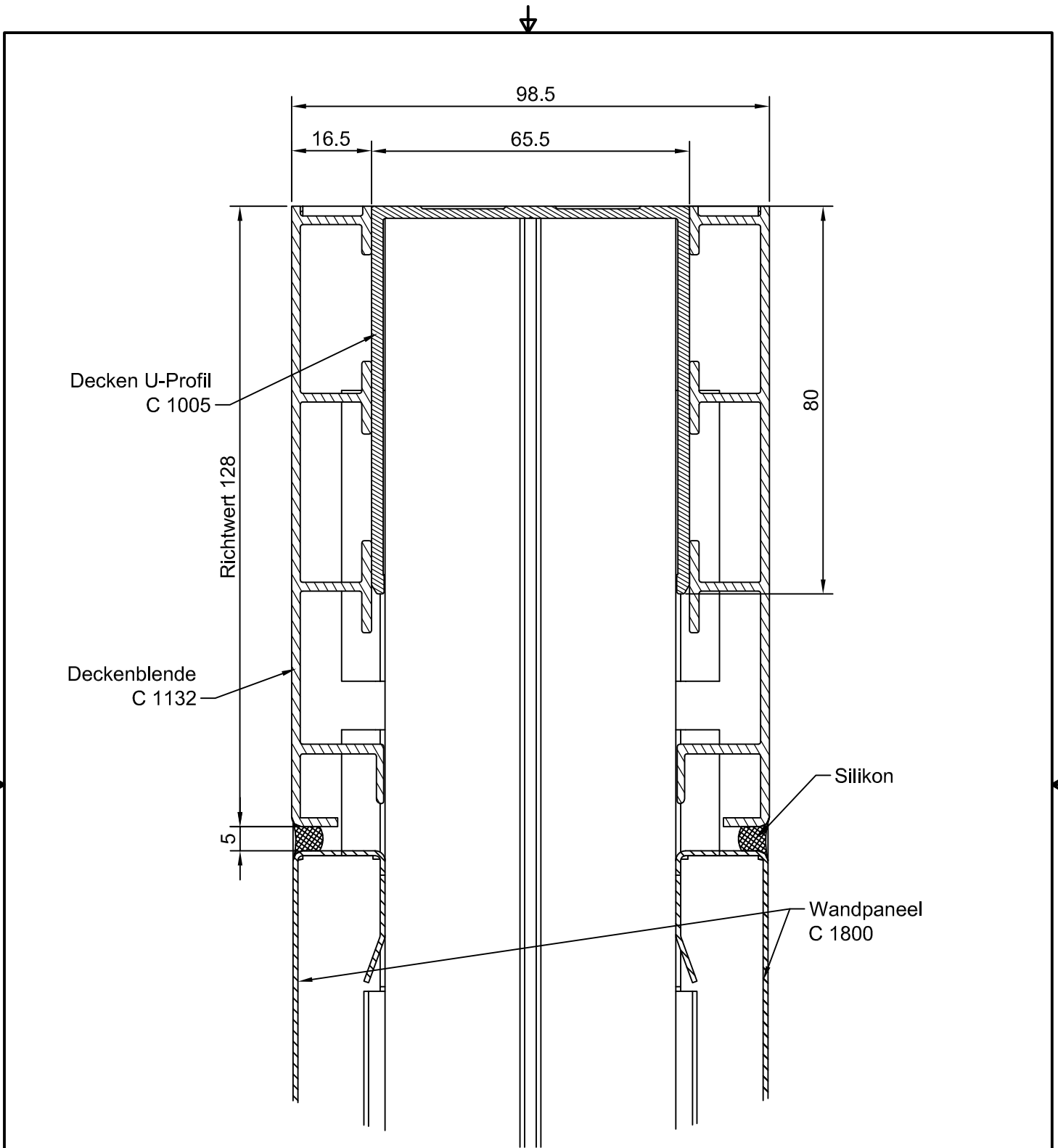

Alle Toleranzen nach DIN ISO 2768 mittel		Material		
This drawing is our literary property and may neither be copied nor to be exposed approachable to third persons without our agreement; according to German Copyright Act				
Gezeichnet	31.07.2014	Norm		Bezeichnung: Wandsystem OCV 98 mm
Kontrolliert				
Projekt Nr.				Z-Nr: VRS_P98_10_0000
Status	Änderungen	Datum	Name	



Alle Toleranzen nach DIN ISO 2768 mittel				Material		
This drawing is our literary property and may neither copied nor to be exposed approachable to third persons without our agreement; according to German Copyright Act						
				Datum	Name	Bezeichnung: Schnitt J: Deckenanschluss
				Gezeichnet	01.08.2014 jk	
				Kontrolliert		
				Norm		
				Projekt Nr.		Z-Nr: VRS_P98_11_0001
Status	Änderungen	Datum	Name			

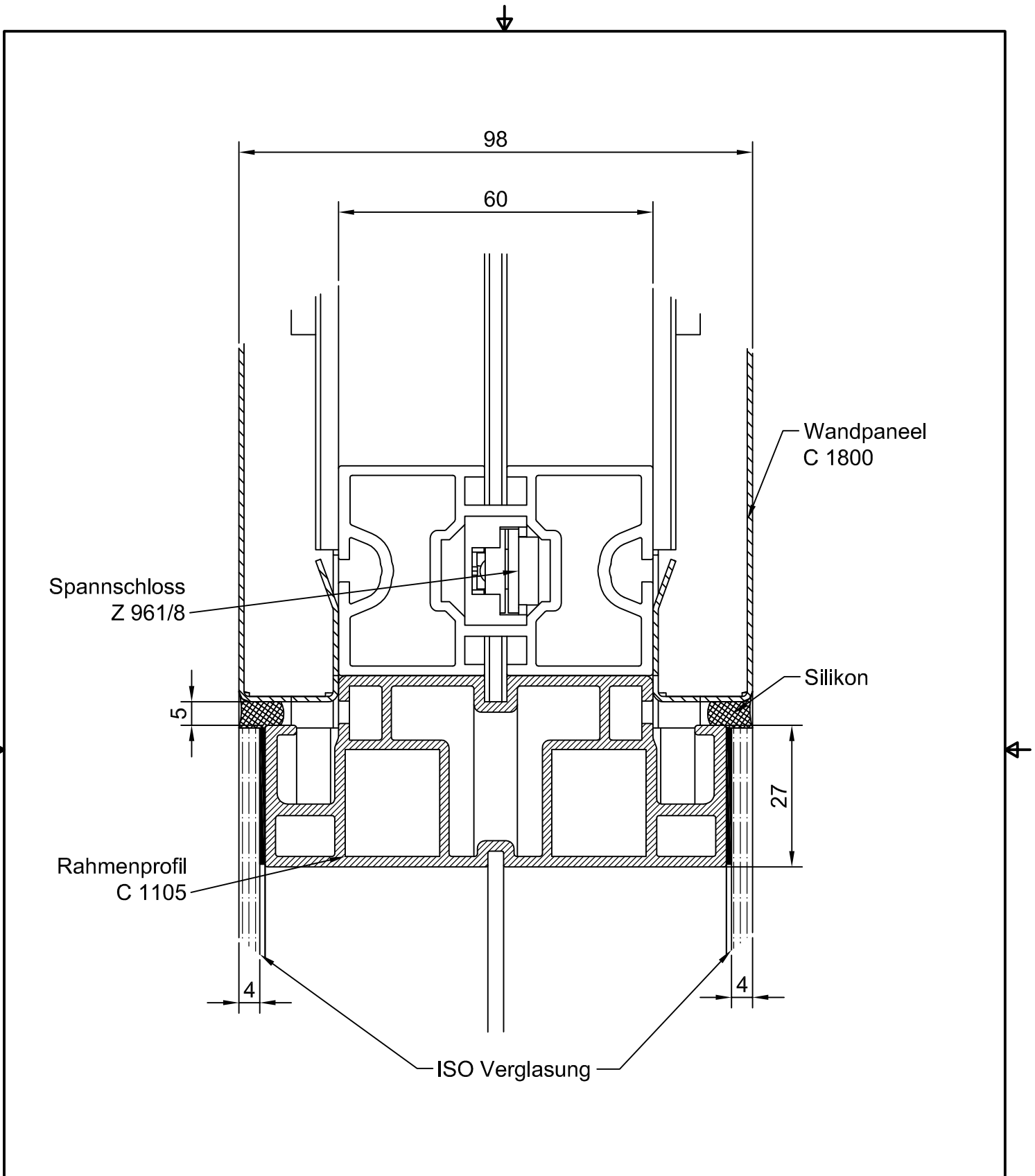

Alle Toleranzen nach DIN ISO 2768 mittel				Material		
This drawing is our literary property and may neither copied nor to be exposed approachable to third persons without our agreement; according to German Copyright Act						
				Datum	Name	Bezeichnung: Schnitt I: Verbindungsanschluss Paneel/ Glas
				Gezeichnet	01.08.2014 jk	
				Kontrolliert		
				Norm		
				Projekt Nr.		Z-Nr: VRS_P98_11_0002
Status	Änderungen	Datum	Name			1 A4

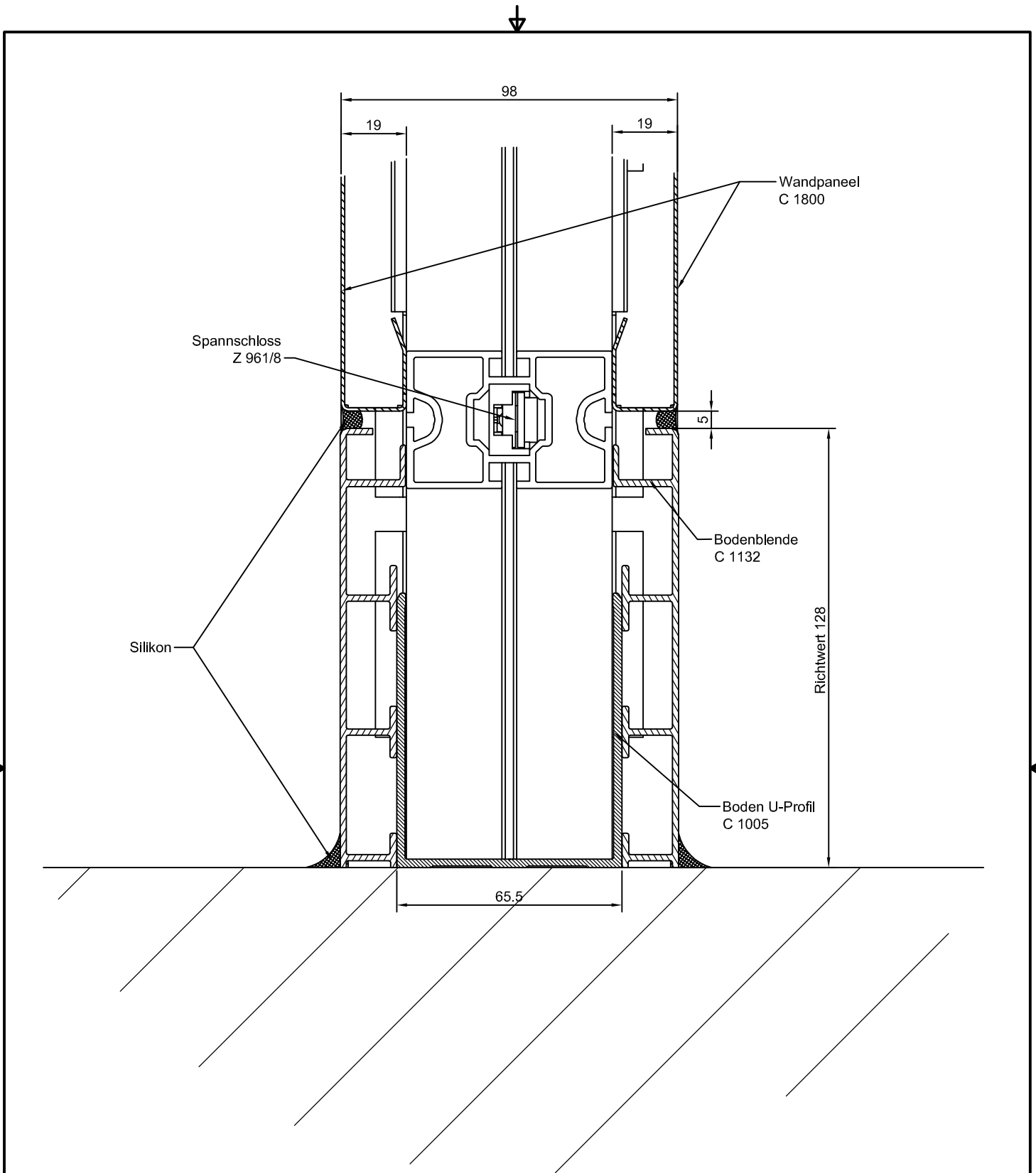

Alle Toleranzen nach DIN ISO 2768 mittel				Material		
This drawing is our literary property and may neither copied nor to be exposed approachable to third persons without our agreement; according to German Copyright Act						
				Datum	Name	Bezeichnung: Schnitt H: Bodenanschluss Typ I
				Gezeichnet	01.08.2014 jk	
				Kontrolliert		
				Norm		
				Projekt Nr.		Z-Nr: VRS_P98_11_0003
Status	Änderungen	Datum	Name			1 A4

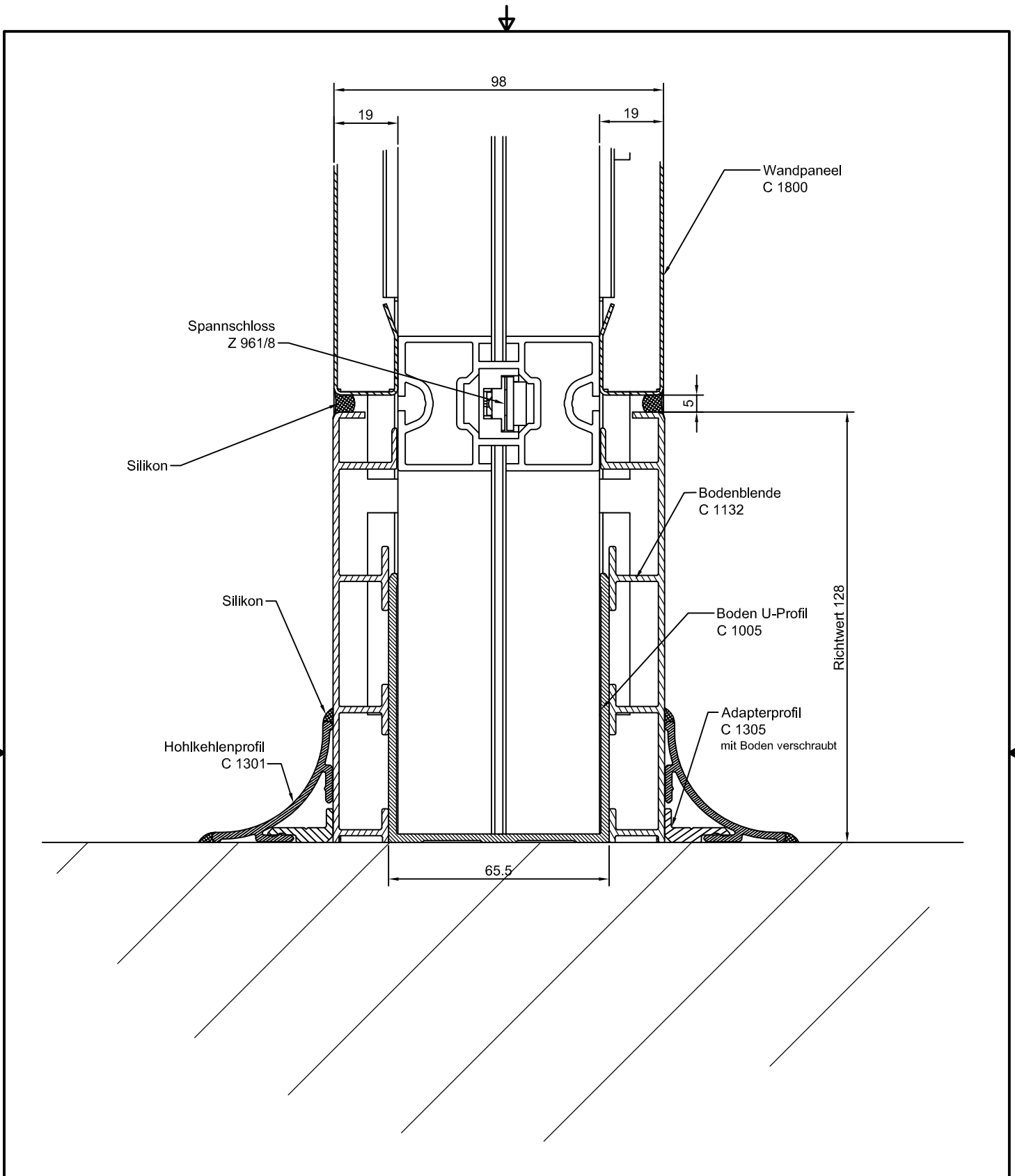

Alle Toleranzen nach DIN ISO 2768 mittel				Material		
This drawing is our literary property and may neither copied nor to be exposed approachable to third persons without our agreement; according to German Copyright Act						
				Datum	Name	Bezeichnung: Schnitt H: Bodenanschluss Typ II
				Gezeichnet	01.08.2014 jk	
				Kontrolliert		
				Norm		
				Projekt Nr.		Z-Nr: VRS_P98_11_0004
Status	Änderungen	Datum	Name			1 A4

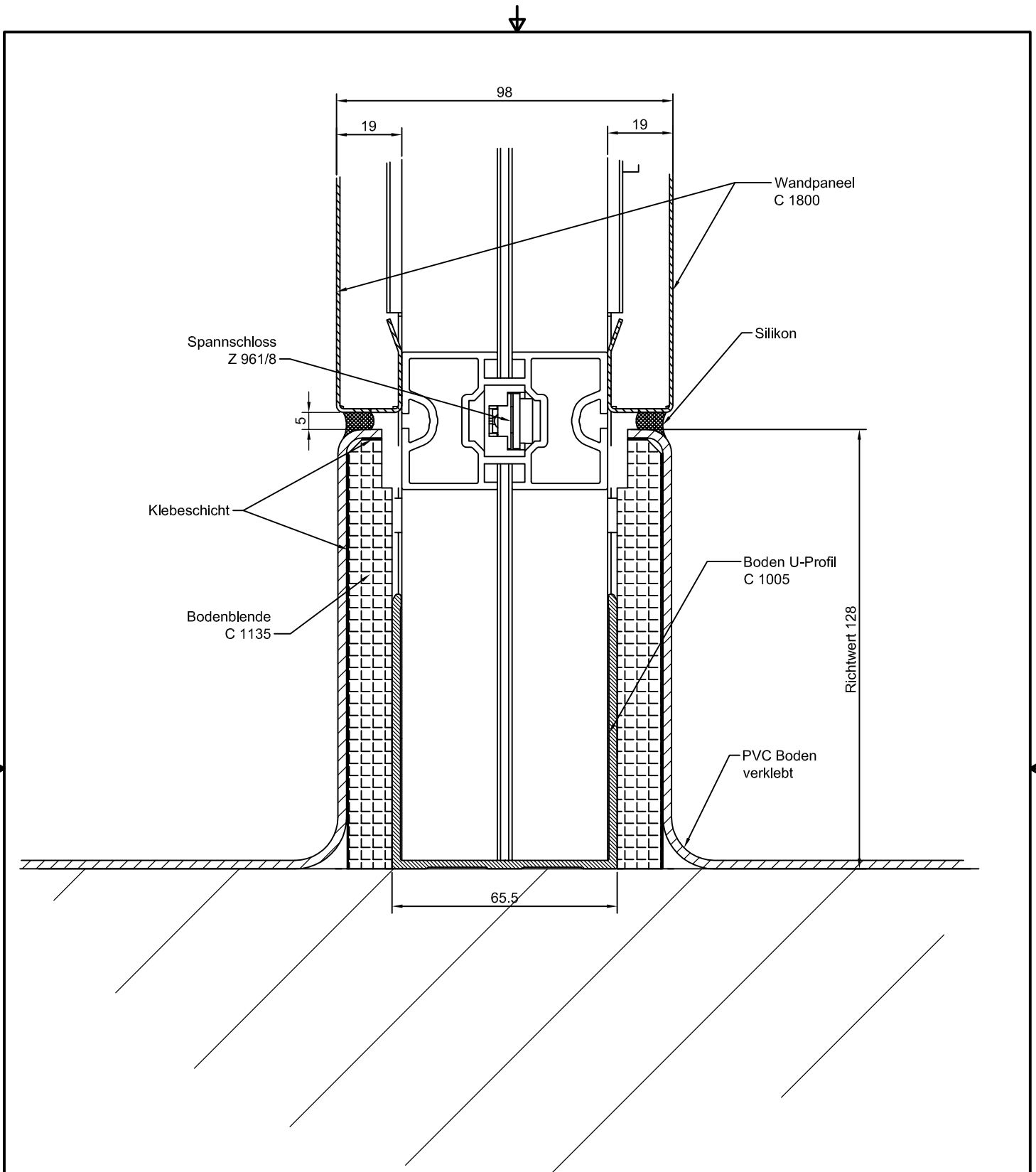

Alle Toleranzen nach DIN ISO 2768 mittel				Material		
This drawing is our literary property and may neither copied nor to be exposed approachable to third persons without our agreement; according to German Copyright Act						
				Datum	Name	Bezeichnung: Schnitt H: Bodenanschluss Typ III
				Gezeichnet	01.08.2014 jk	
				Kontrolliert		
				Norm		
				Projekt Nr.		Z-Nr: VRS_P98_11_0005
Status	Änderungen	Datum	Name			1 A4

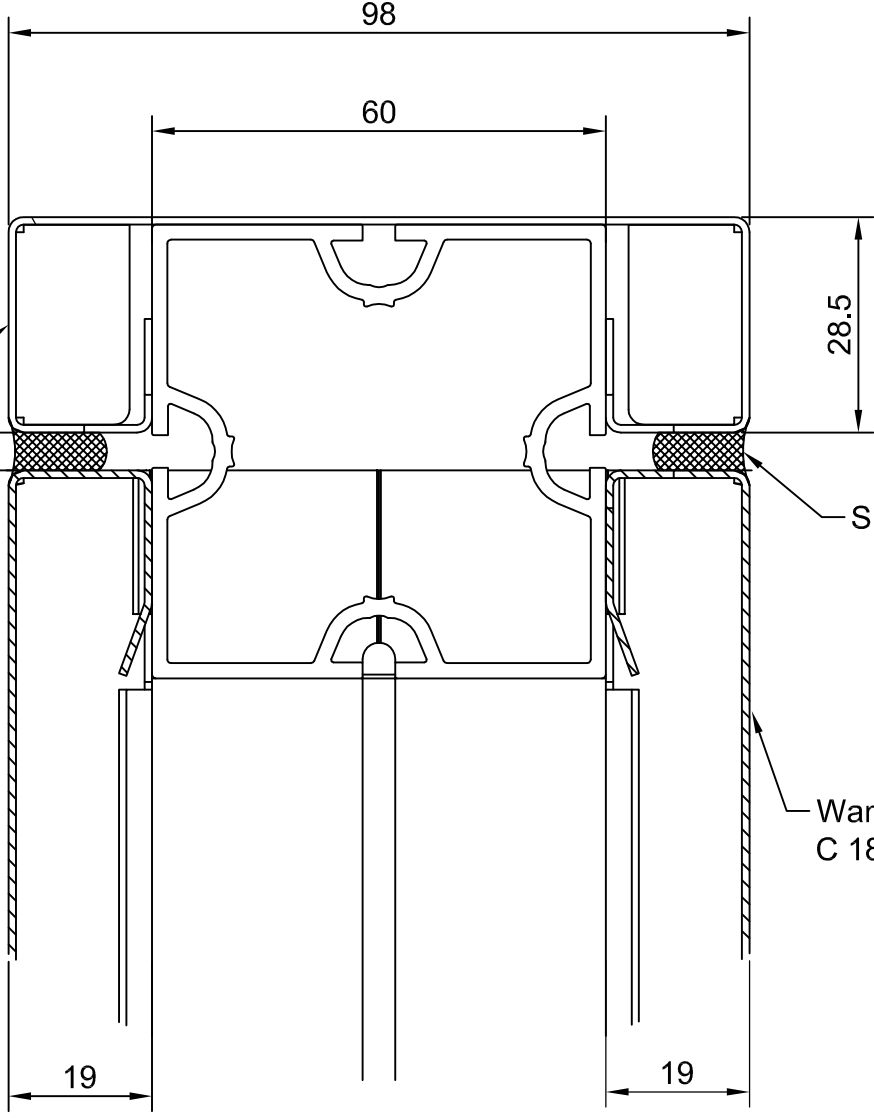

Abschlussblende
C 1267

5

98

60

28.5

Silikon

Wandpaneel
C 1800

19

19

Alle Toleranzen nach DIN ISO 2768 mittel

Material

This drawing is our literary property and may neither copied nor to be exposed approachable to third persons without our agreement; according to German Copyright Act



	Datum	Name
Gezeichnet	31.07.2014	jk
Kontrolliert		
Norm		

Bezeichnung:
Schnitt C:
Wandabschluss

Status	Änderungen	Datum	Name

Projekt Nr.

Z-Nr: VRS_P98_12_0001

1
A4



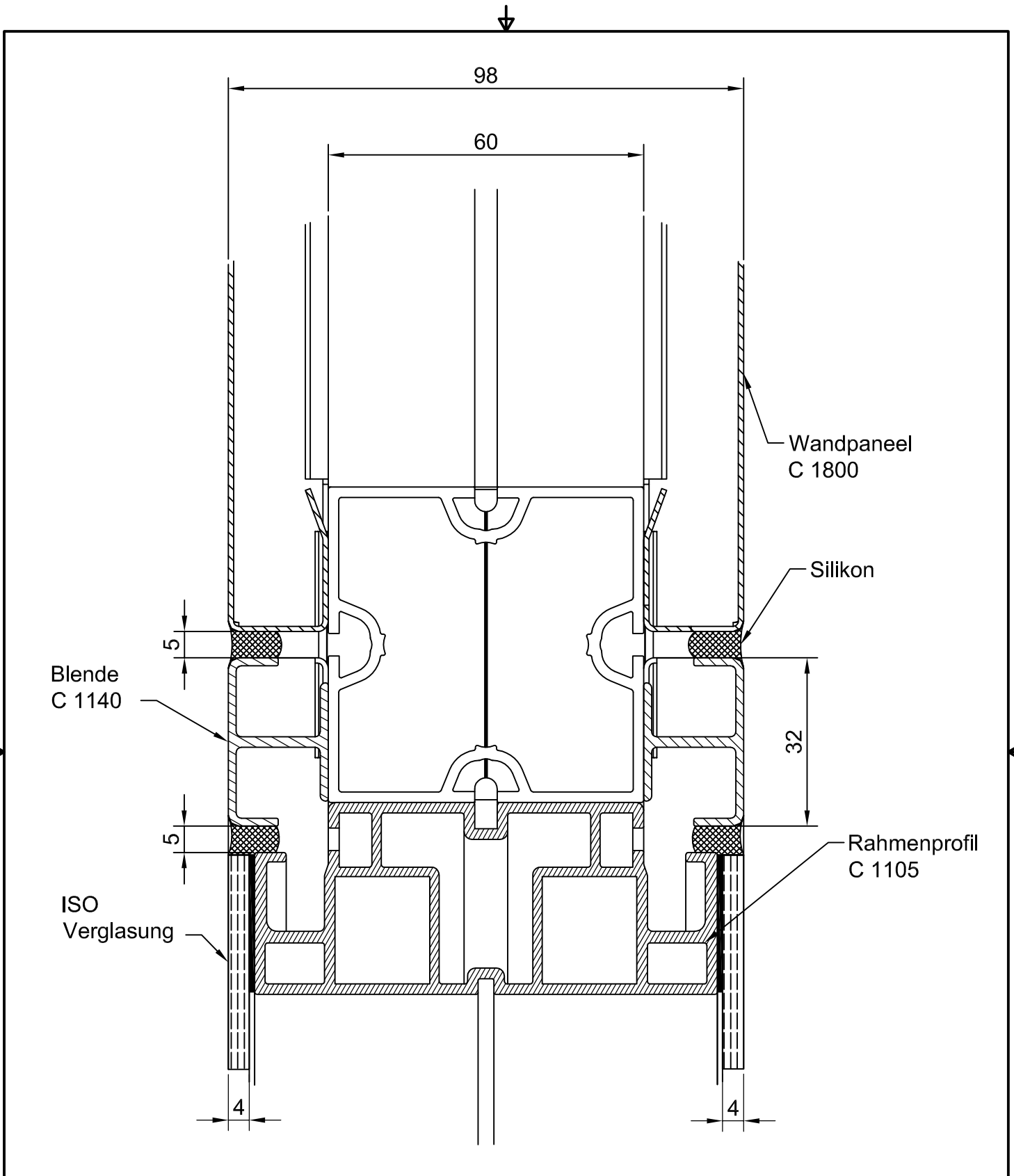

Alle Toleranzen nach DIN ISO 2768 mittel				Material		
This drawing is our literary property and may neither copied nor to be exposed approachable to third persons without our agreement; according to German Copyright Act						
				Datum	Name	Bezeichnung: Schnitt D: Verbindungsanschluss Paneel/ Glas
				Gezeichnet	31.07.2014 jk	
				Kontrolliert		
				Norm		
				Projekt Nr.		Z-Nr: VRS_P98_12_0002
Status	Änderungen	Datum	Name			

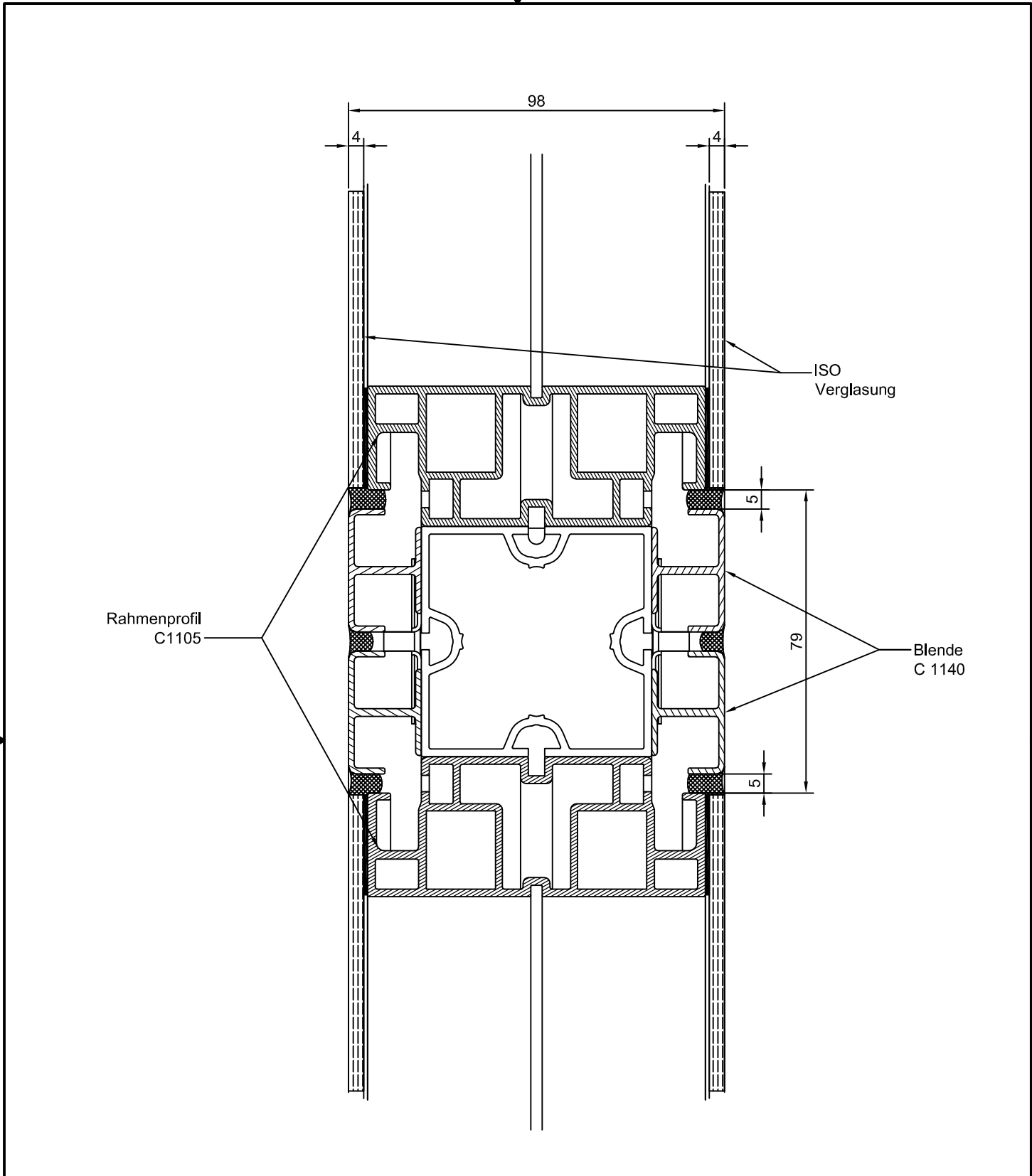

Alle Toleranzen nach DIN ISO 2768 mittel				Material			
This drawing is our literary property and may neither copied nor to be exposed approachable to third persons without our agreement; according to German Copyright Act							
				Datum	Name	Bezeichnung: Schnitt E: Verbindungsanschluss Glas/ Glas	
				Gezeichnet	31.07.2014		jk
				Kontrolliert			
				Norm			
				Projekt Nr.		Z-Nr: VRS_P98_12_0003	
							1 A4
Status	Änderungen	Datum	Name				



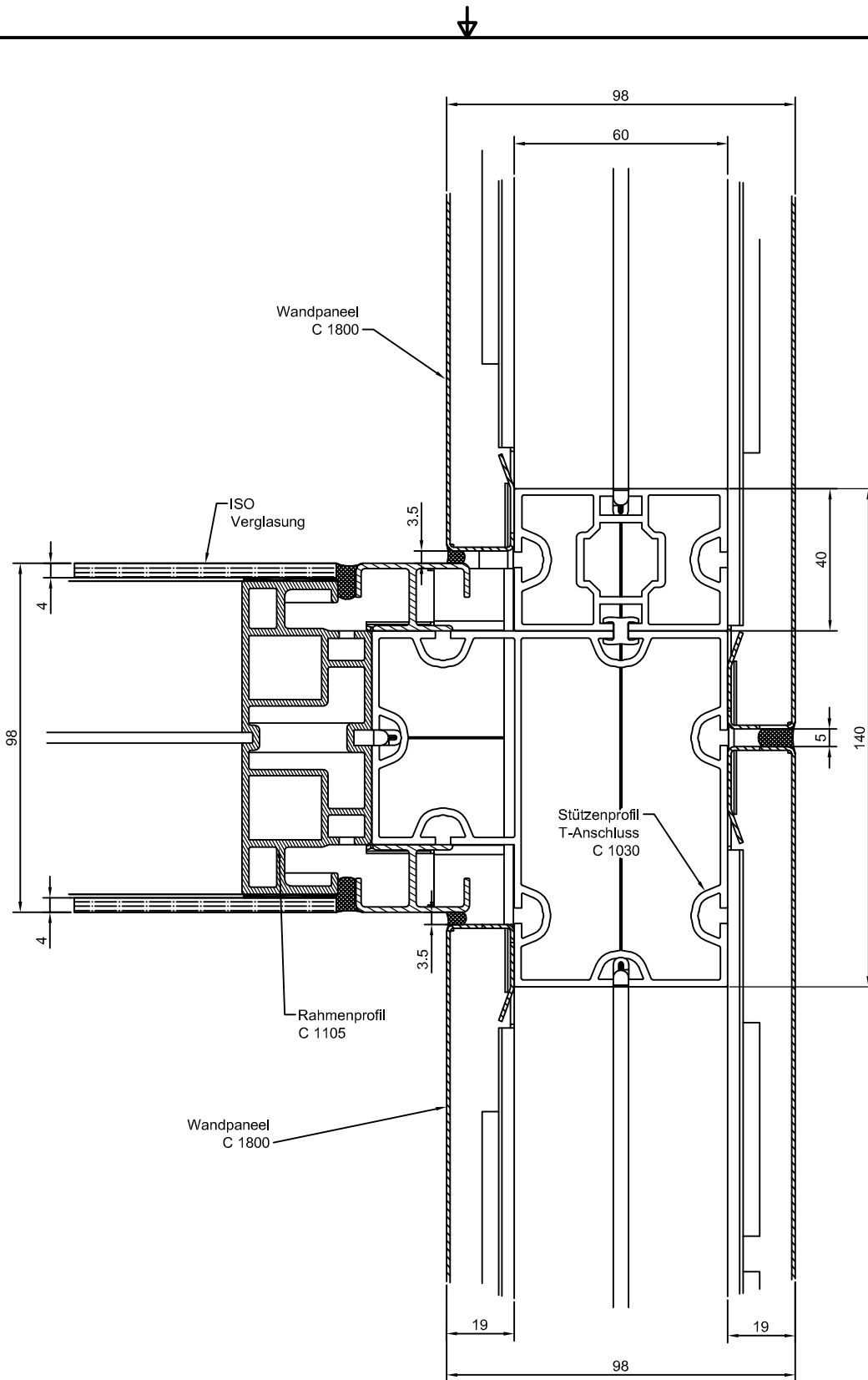

Alle Toleranzen nach DIN ISO 2768 mittel

Material

This drawing is our literary property and may neither copied nor to be exposed approachable to third persons without our agreement; according to German Copyright Act

OCTANORM 

				Datum	Name
				Gezeichnet 31.07.2014	jk
				Kontrolliert	
				Norm	

Bezeichnung:
Schnitt F:
T - Anschluss Glas/ Paneel/ Pabeel

				Projekt Nr.
Status	Änderungen	Datum	Name	

Z-Nr: VRS_P98_12_0004

1
A4

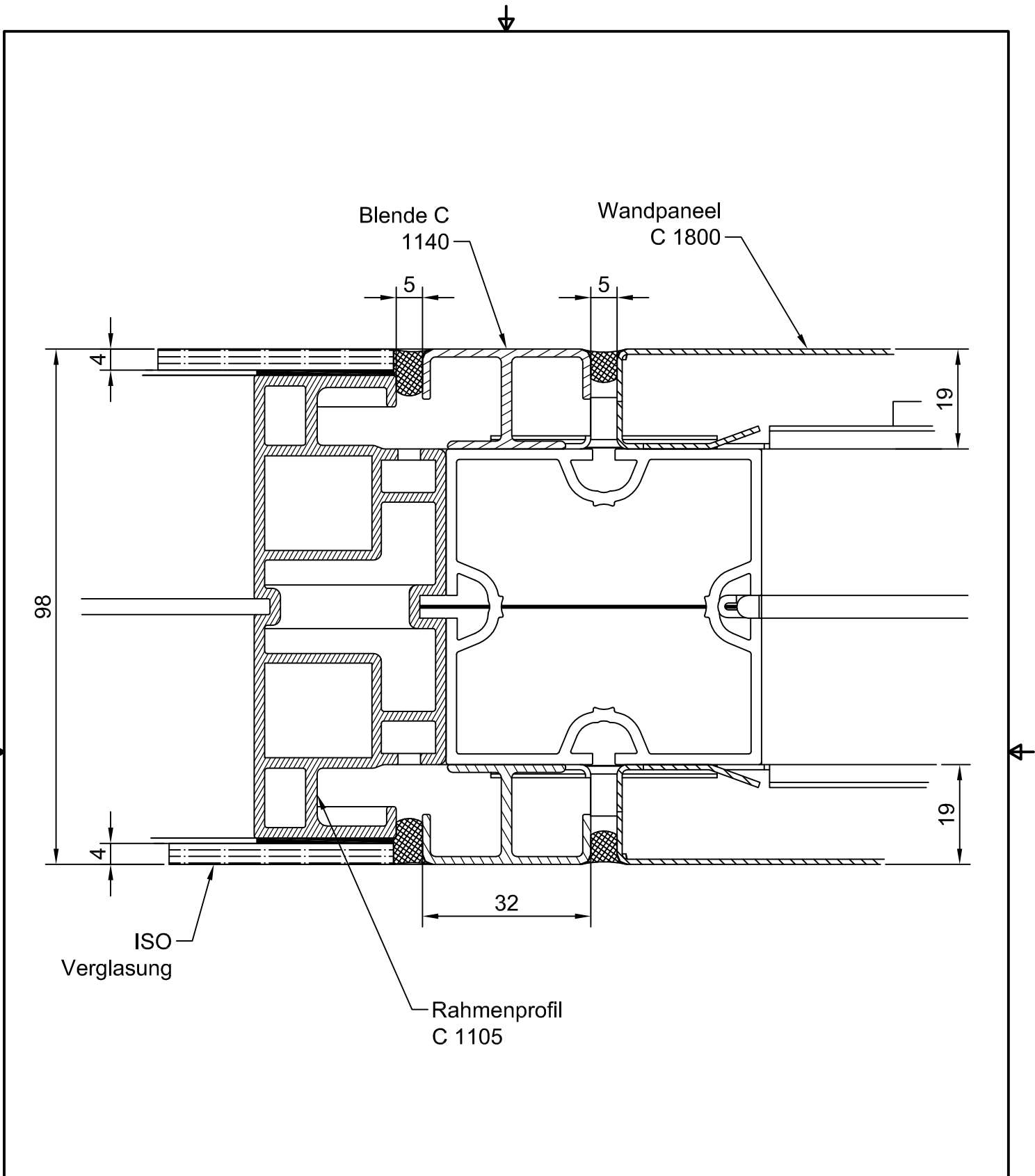

Alle Toleranzen nach DIN ISO 2768 mittel				Material		
This drawing is our literary property and may neither copied nor to be exposed approachable to third persons without our agreement; according to German Copyright Act						
				Datum	Name	Bezeichnung: Schnitt G: Verbindungsanschluss Paneel/ Glas
				Gezeichnet	01.08.2014 jk	
				Kontrolliert		
				Norm		
				Projekt Nr.		Z-Nr: VRS_P98_12_0005
Status	Änderungen	Datum	Name			1 A4

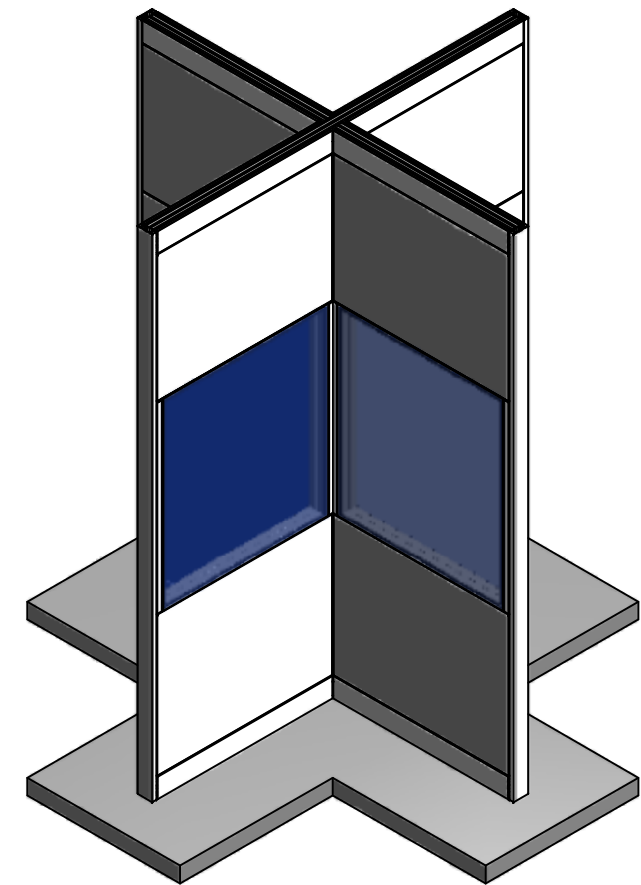
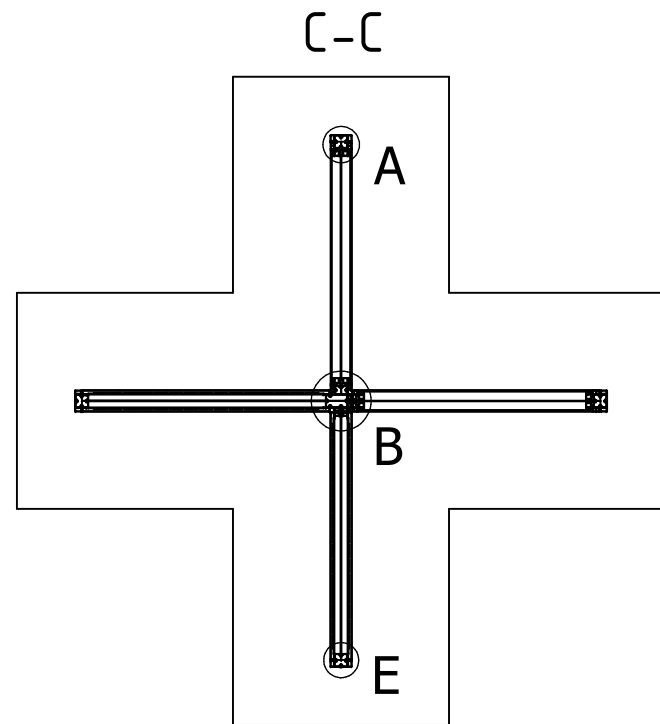
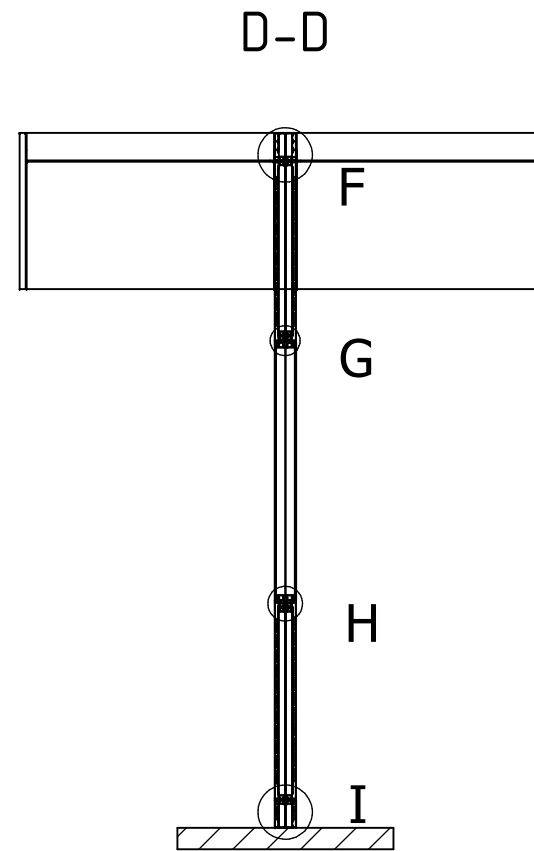
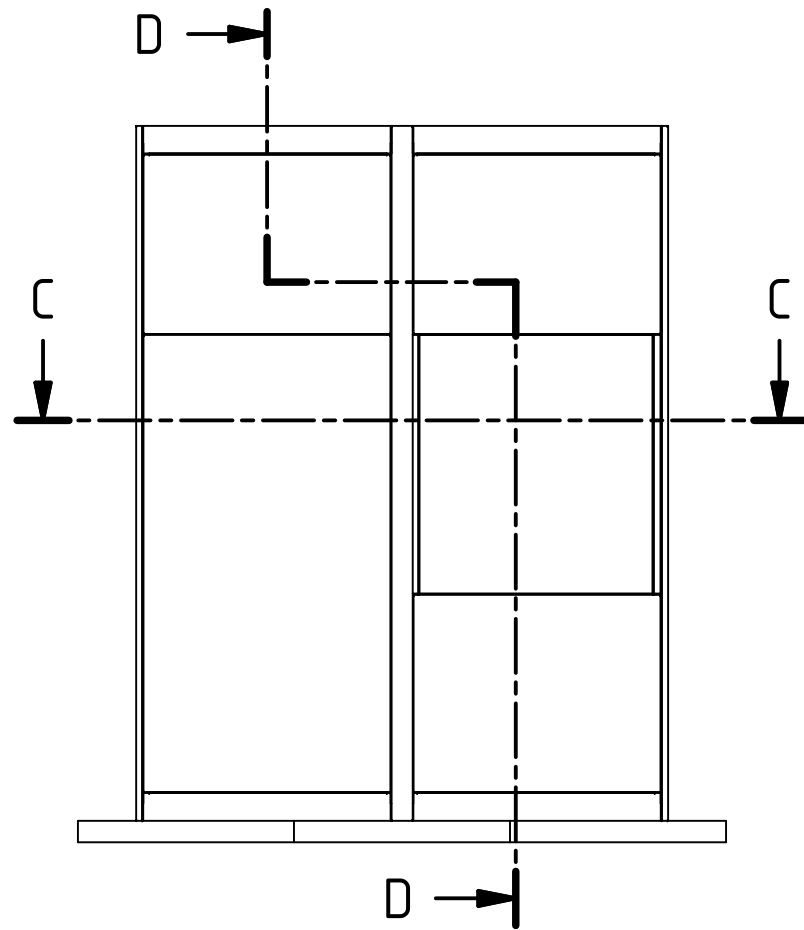

Alle Toleranzen nach DIN ISO 2768 mittel				Material		
This drawing is our literary property and may neither copied nor to be exposed approachable to third persons without our agreement; according to German Copyright Act						
				Datum	Name	Bezeichnung: Wansystem OCV 98 mm Wandkreuzung
				Gezeichnet	01.08.2014 jk	
				Kontrolliert		
				Norm		Z-Nr:VRS_P98_20_0000
				Projekt Nr.		
Status	Änderungen	Datum	Name			1 A3

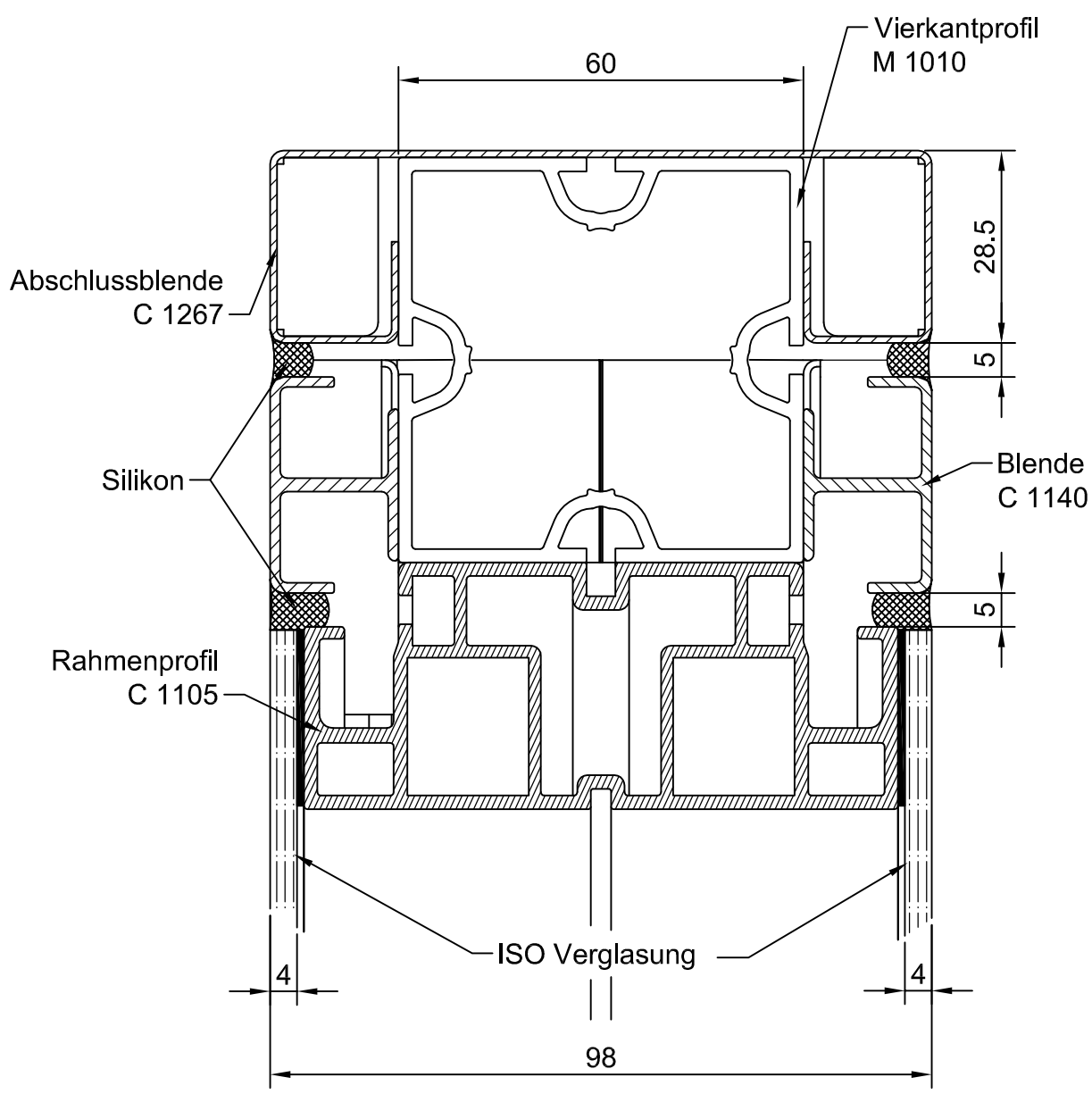

Alle Toleranzen nach DIN ISO 2768 mittel

This drawing is our literary property and may neither copied nor to be exposed approachable to third persons without our agreement; according to German Copyright Act

Material



				Datum	Name
				Gezeichnet 04.08.2014	jk
				Kontrolliert	
				Norm	
				Projekt Nr.	
Status	Änderungen	Datum	Name		

Bezeichnung:	
Schnitt A: Wandabschluss	
Z-Nr: VRS_P98_22_0001	1
	A4

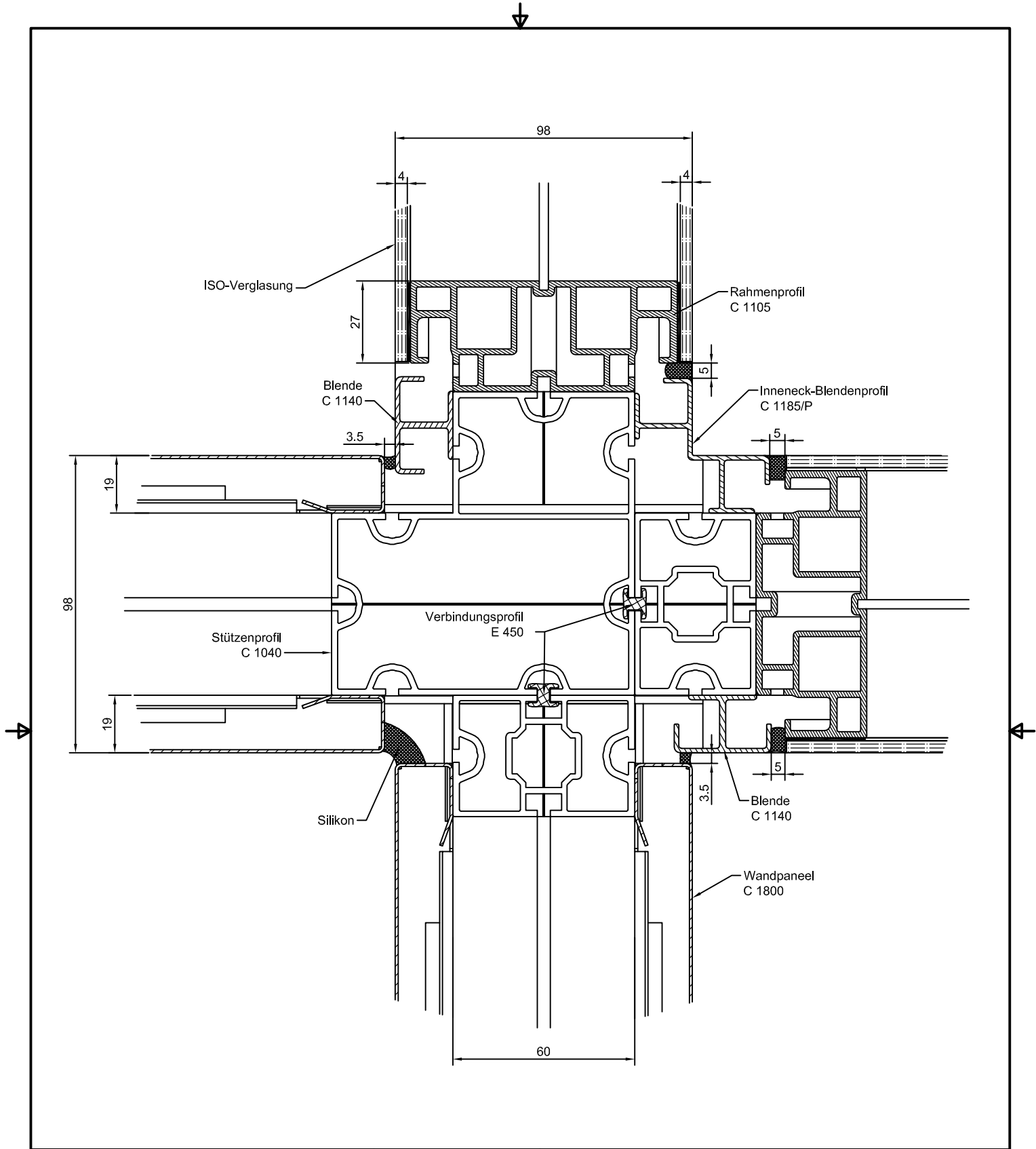

Alle Toleranzen nach DIN ISO 2768 mittel

This drawing is our literary property and may neither copied nor to be exposed approachable to third persons without our agreement; according to German Copyright Act

Material



Datum	Name
Gezeichnet 04.08.2014	jk
Kontrolliert	
Norm	

Bezeichnung:
Schnitt B:
Kreuz-Anschluss Paneel/ Paneel/ Glas/ Glas

Status	Änderungen	Datum	Name

Projekt Nr.

Z-Nr: VRS_P98_22_0002

1
A4

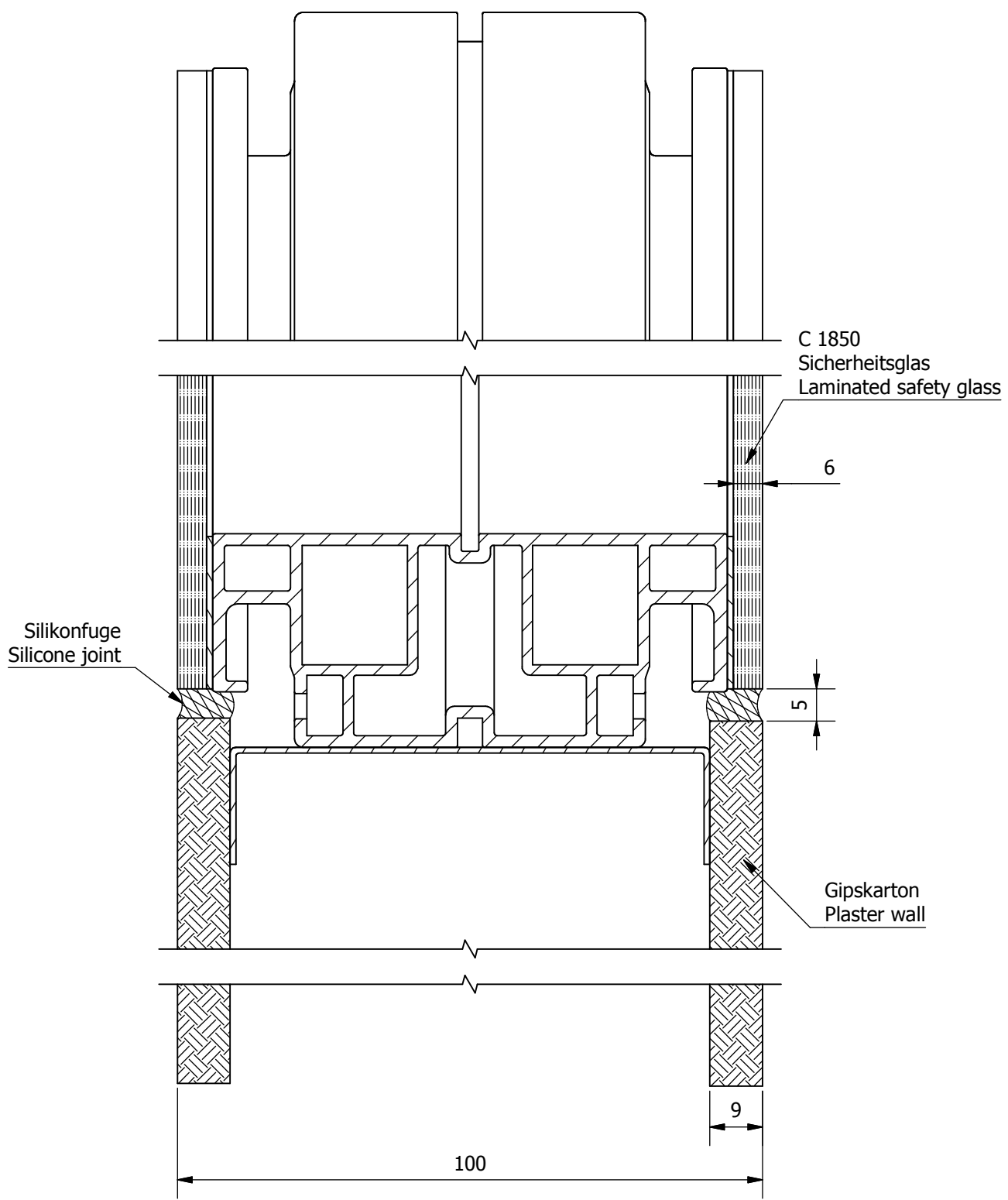

Alle Toleranzen nach DIN ISO 2768 mittel

Material

This drawing is our literary property and may neither copied nor to be exposed approachable to third persons without our agreement; according to German Copyright Act



Description / Bezeichnung:

Wandanschluss Verglasung/ Gipskarton
Wall connection glazing/ plaster panel

		Datum	Name
	Gezeichnet	02.12.2014	jk
	Kontrolliert		
	Norm		
Projekt Nr.			
Status	Änderungen	Datum	Name

Z-Nr:VRS_P98_30_0001

1

A4